

APRONS 1/7

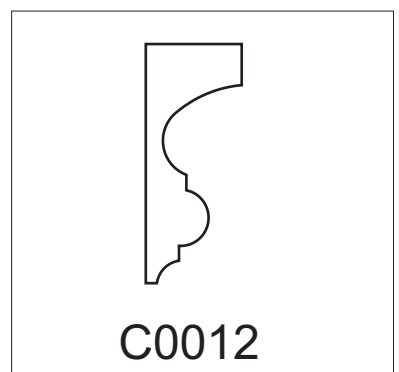

APRONS 2/7

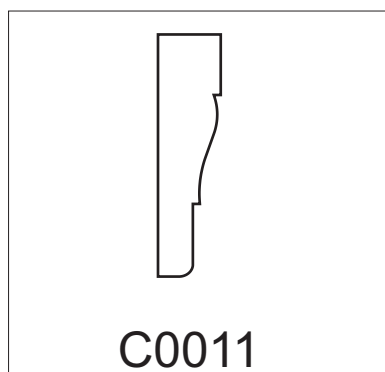
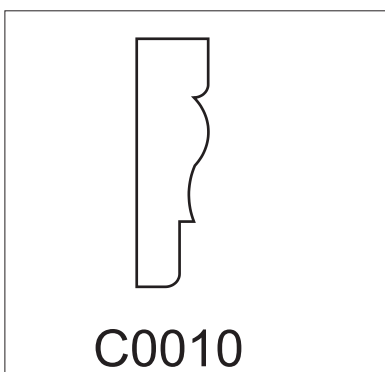
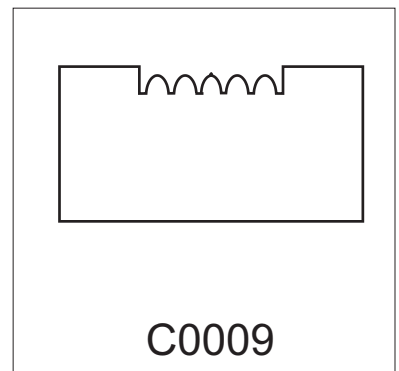
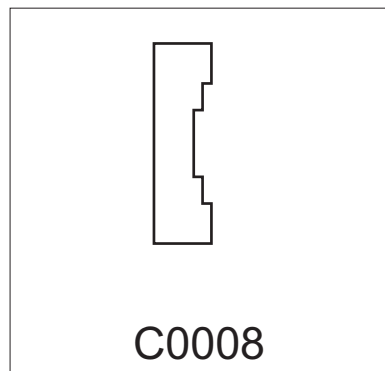
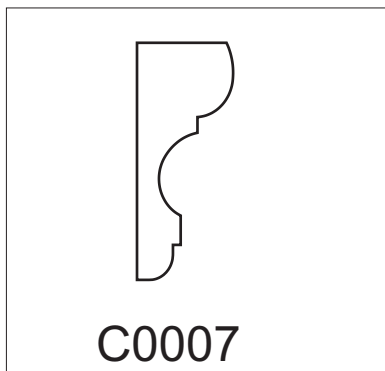
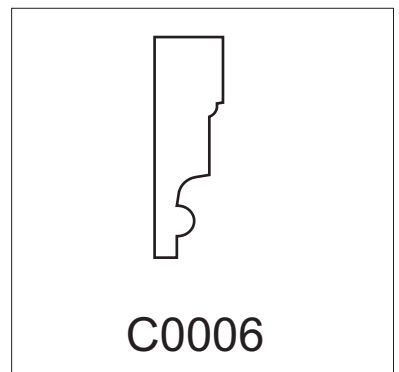
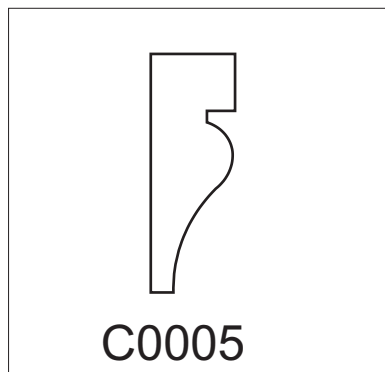
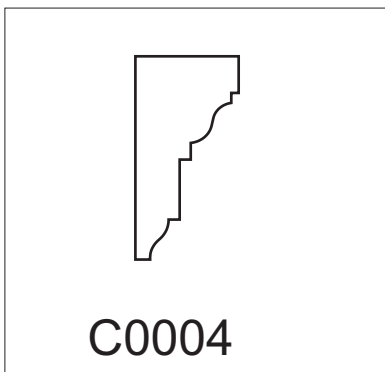
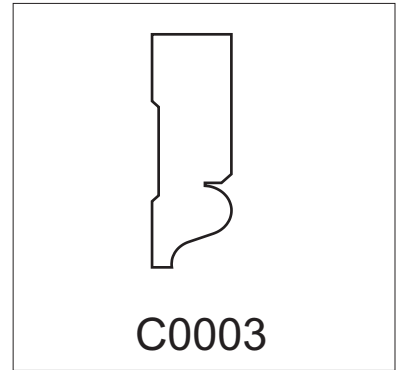
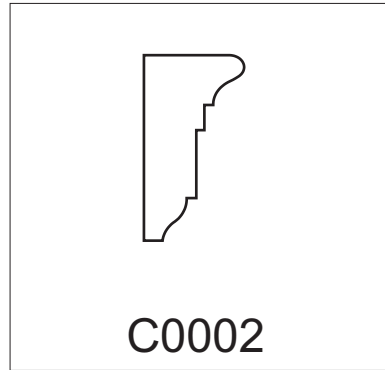
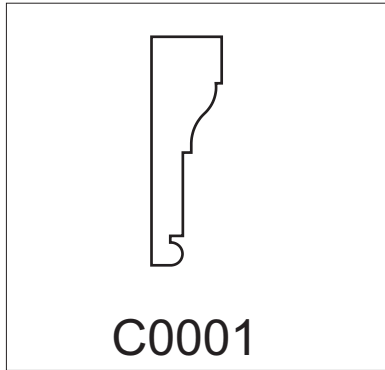
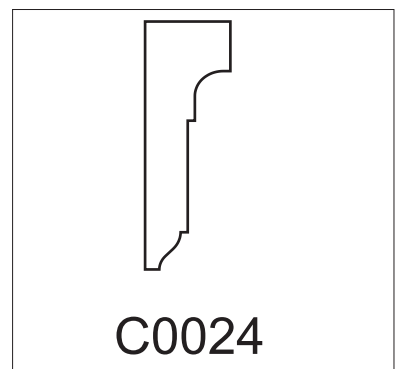
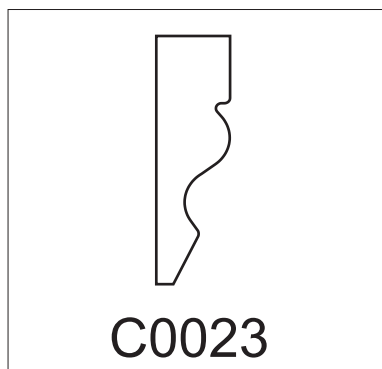
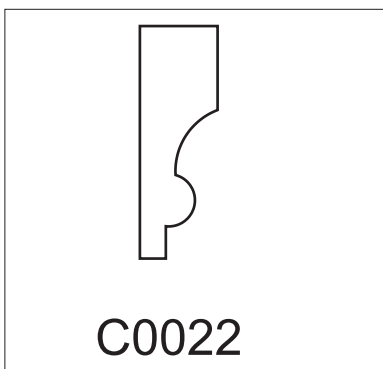
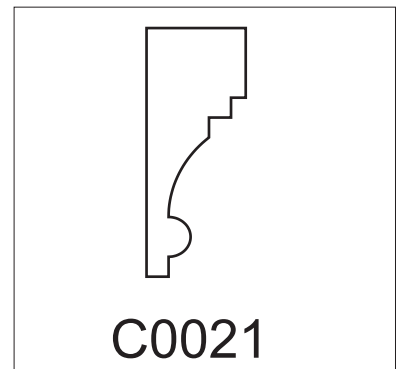
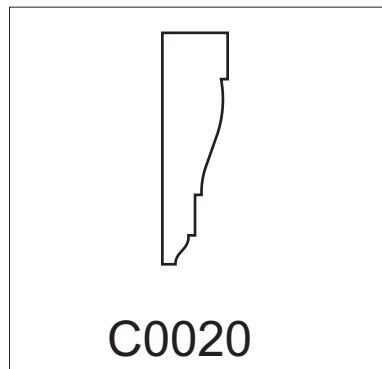
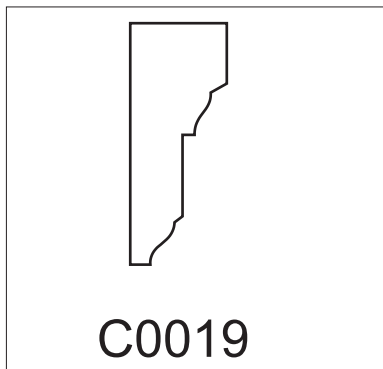
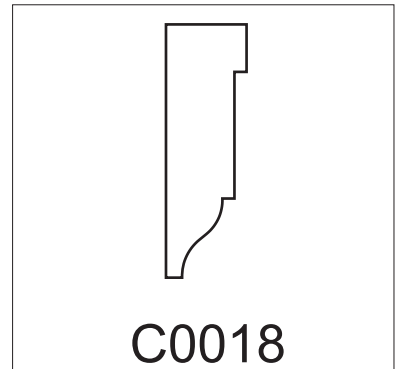
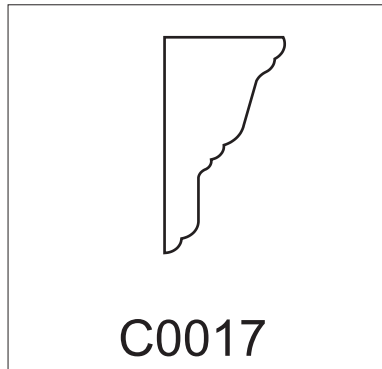
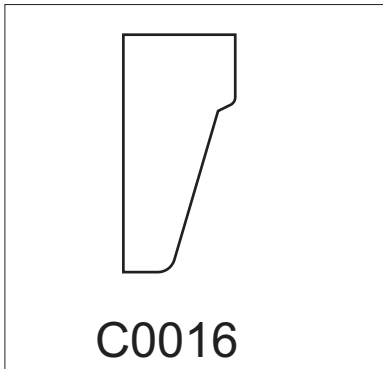
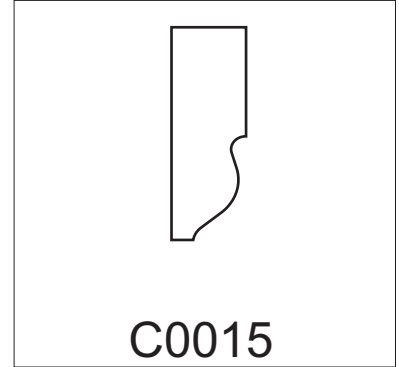
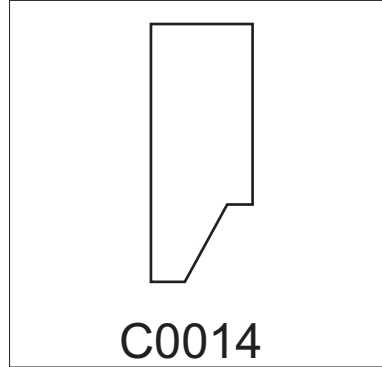
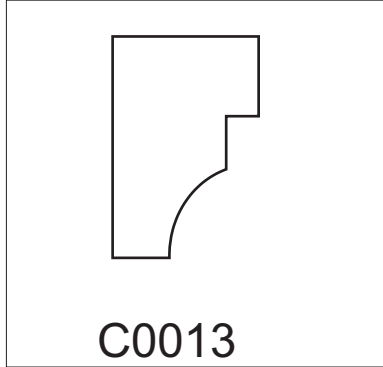

APRONS 3/7

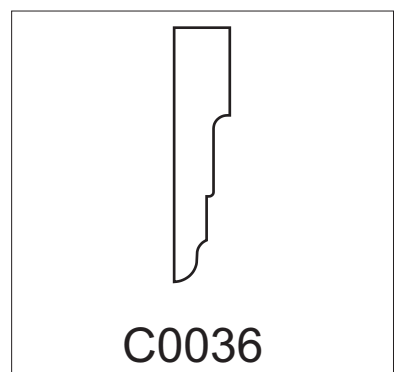
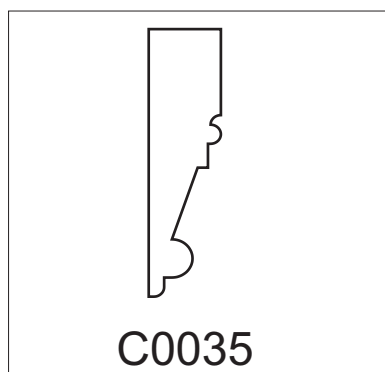
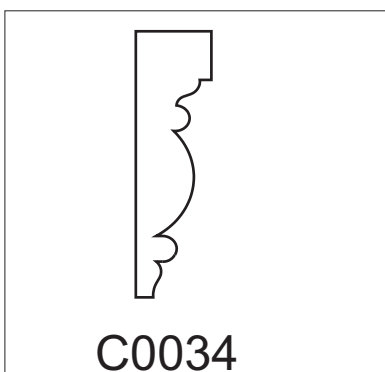
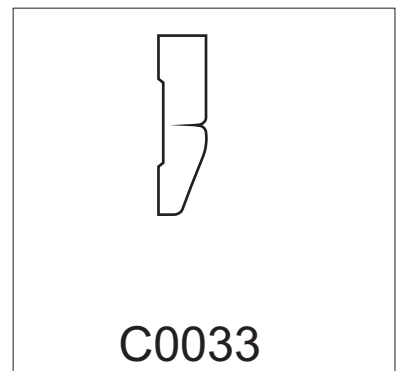
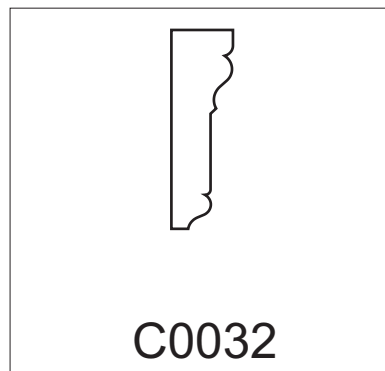
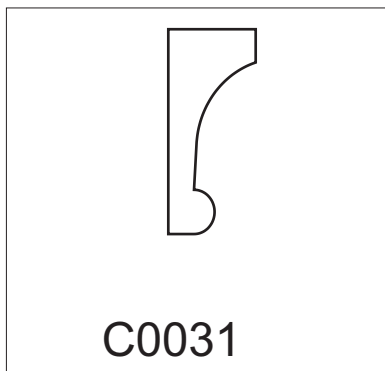
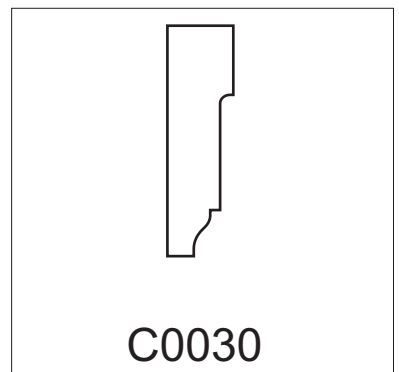
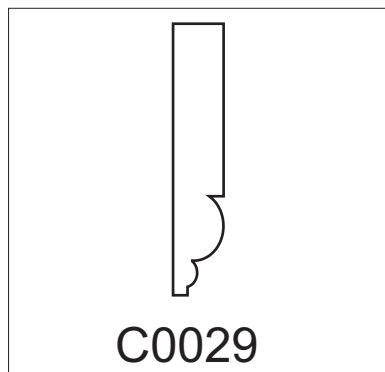
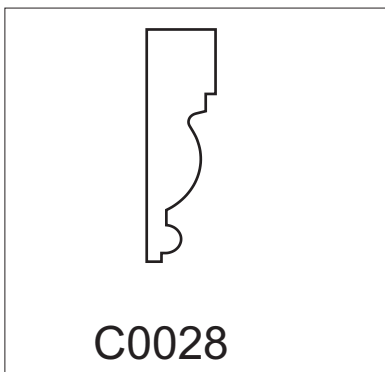
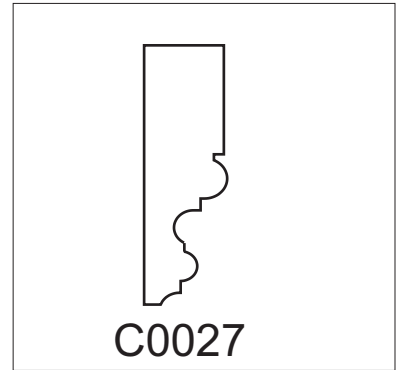
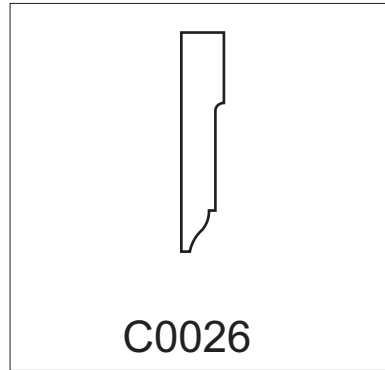
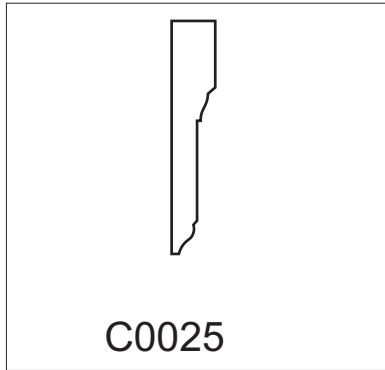

APRONS 4/7

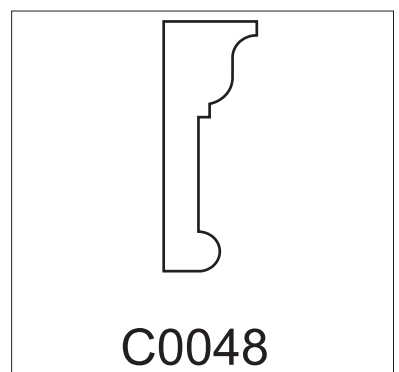
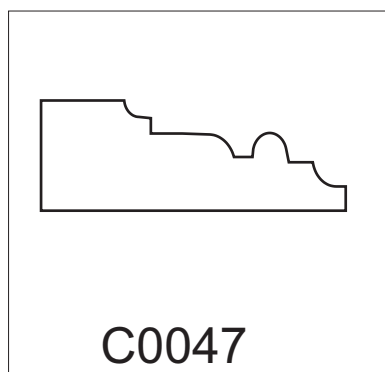
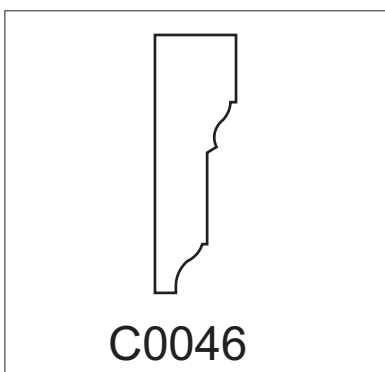
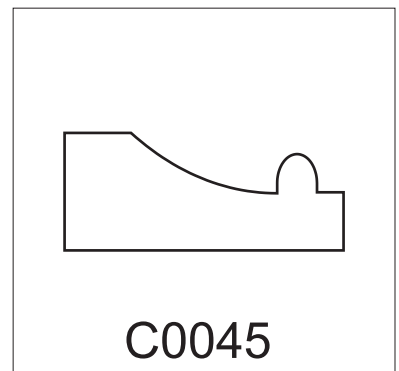
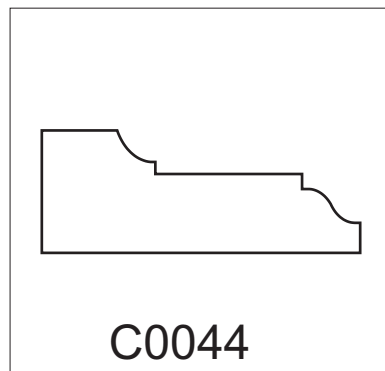
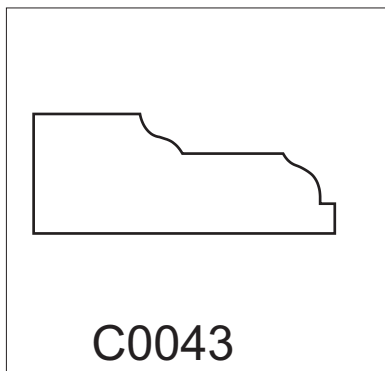
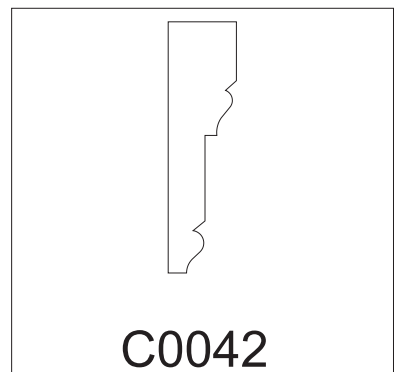
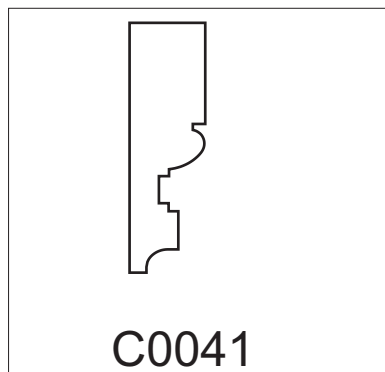
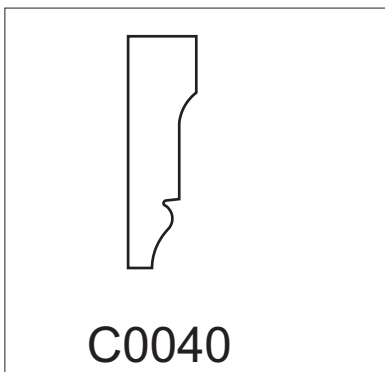
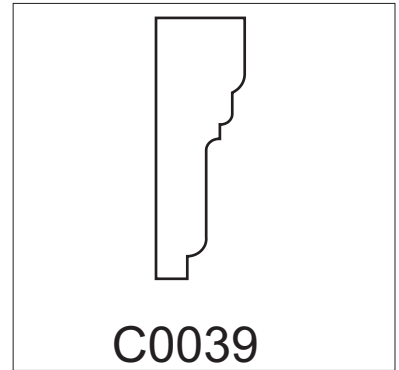
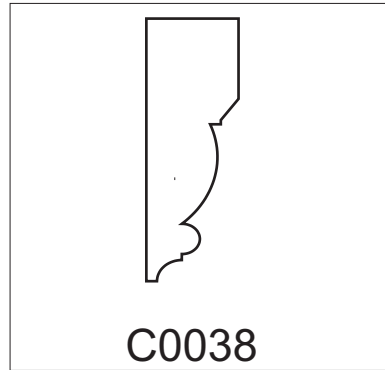
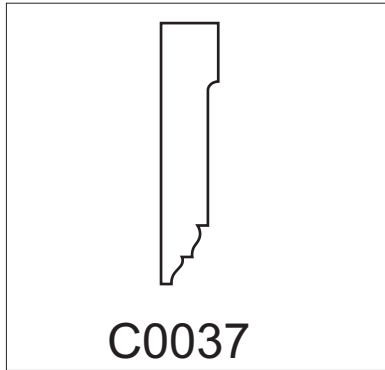

APRONS 5/7

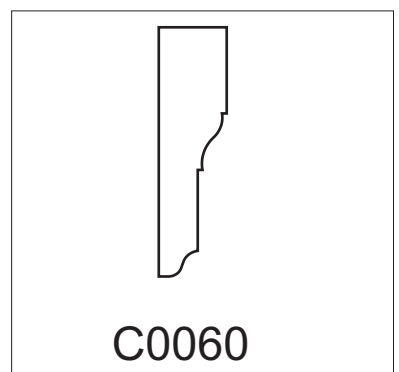
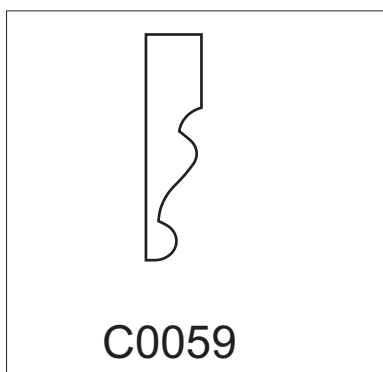
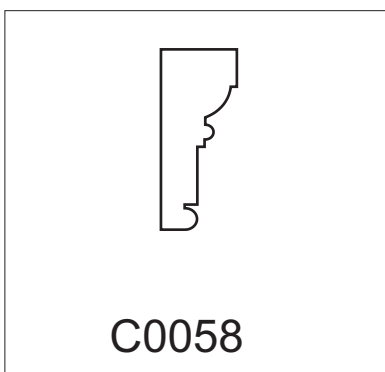
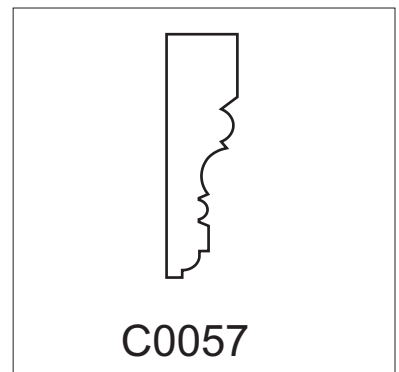
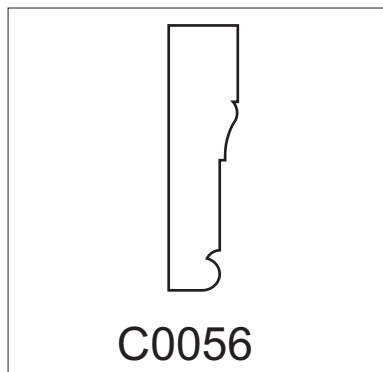
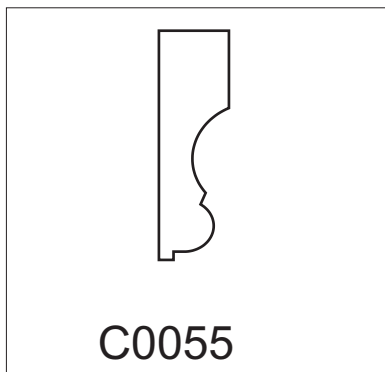
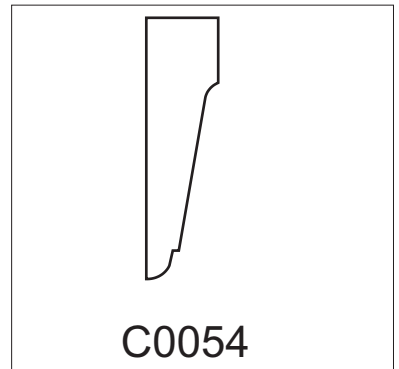
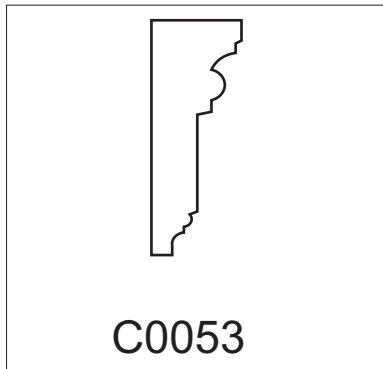
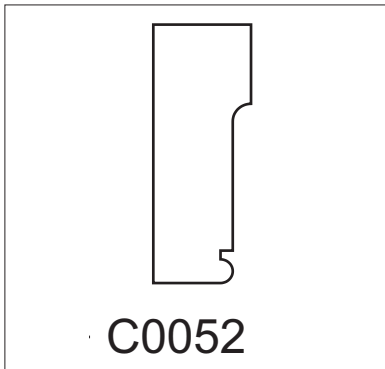
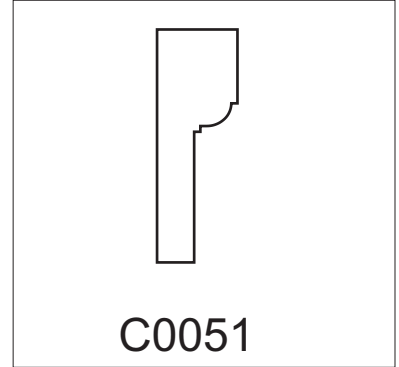
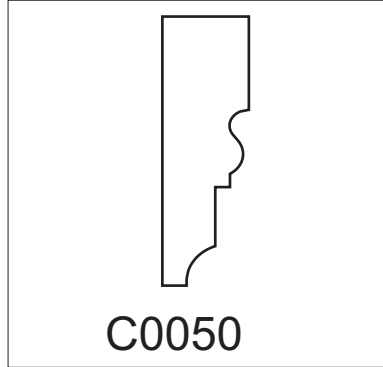
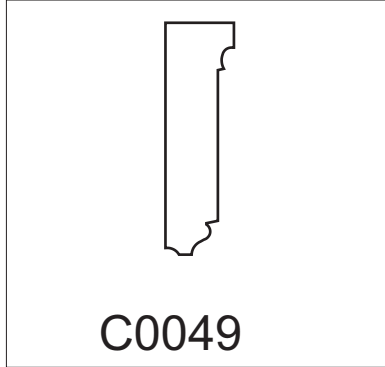

APRONS 6/7

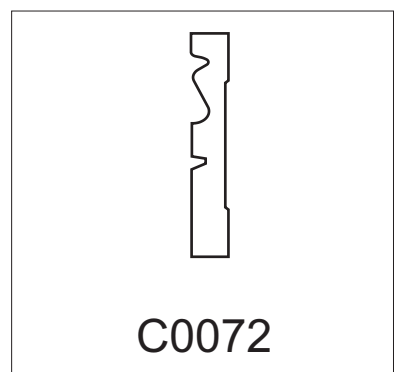
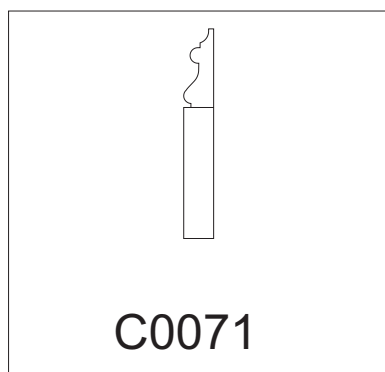
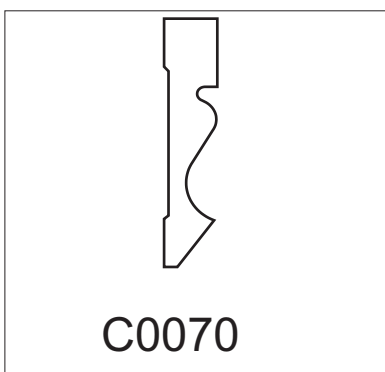
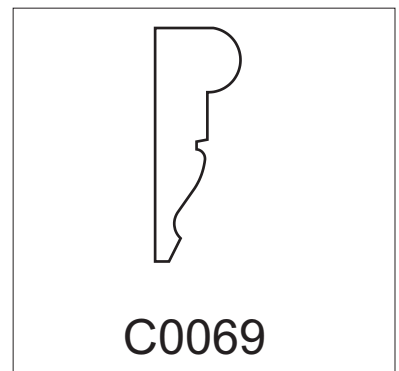
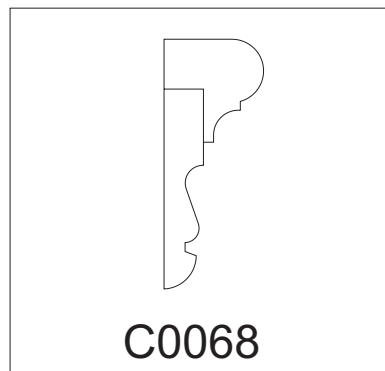
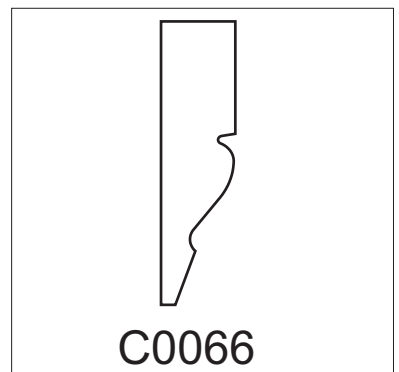
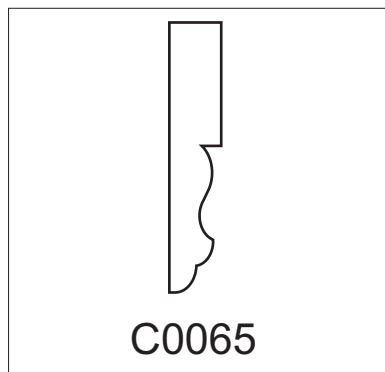
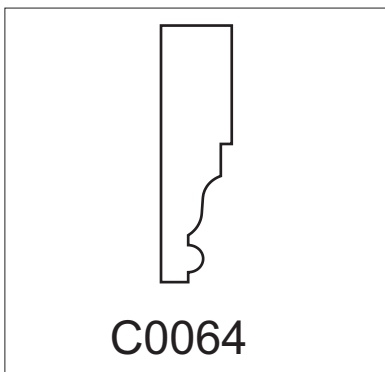
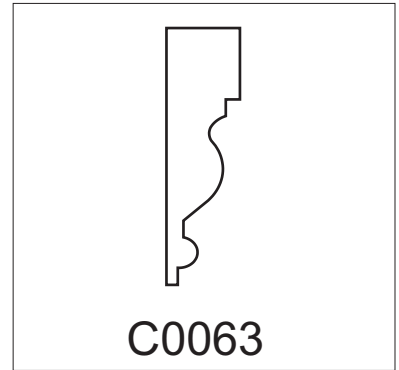
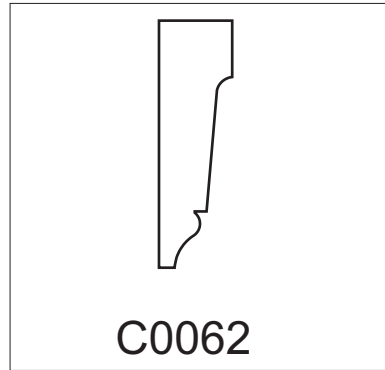
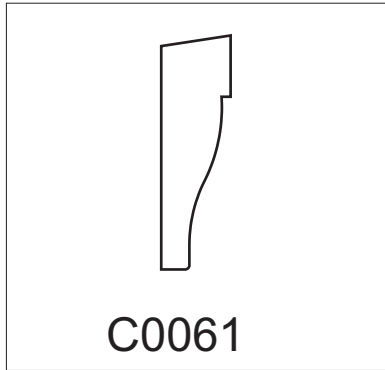

APRONS 7/7

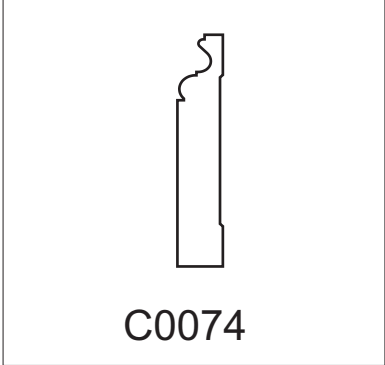
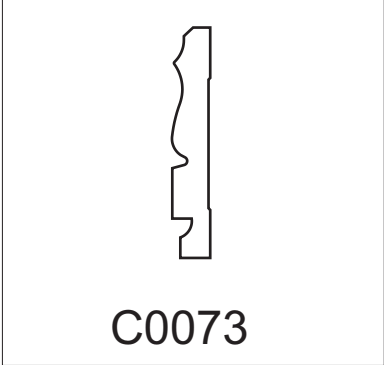

ASTRAGALS 1/4

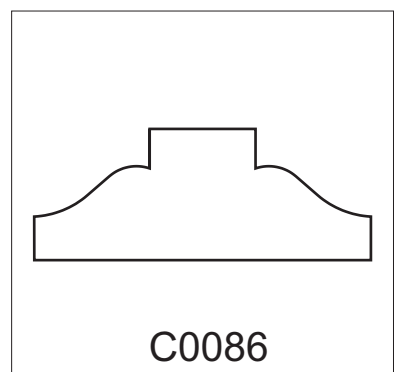
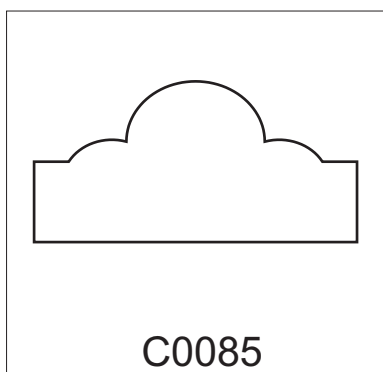
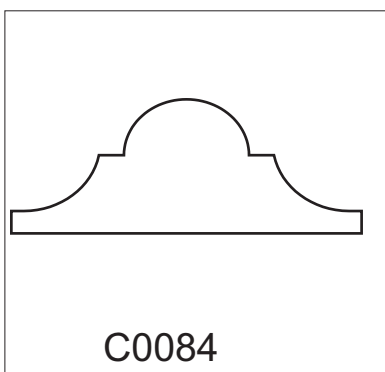
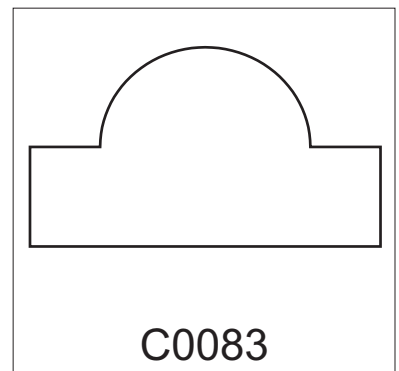
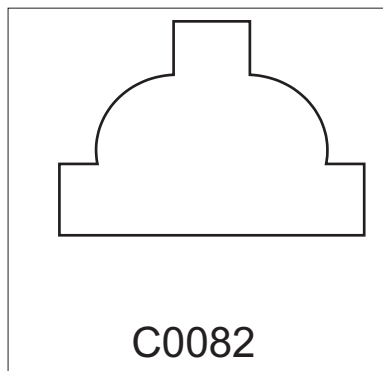
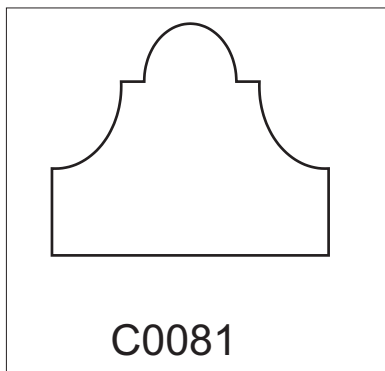
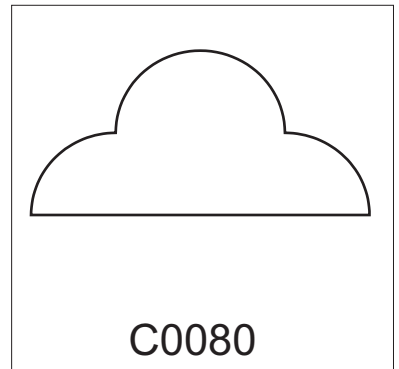
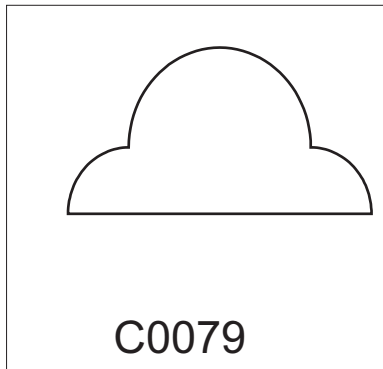
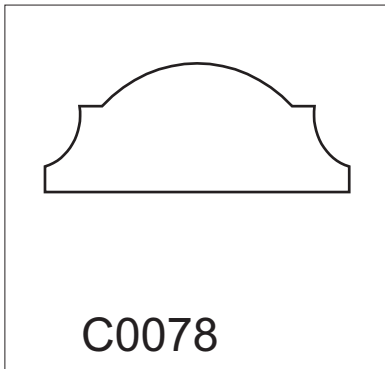
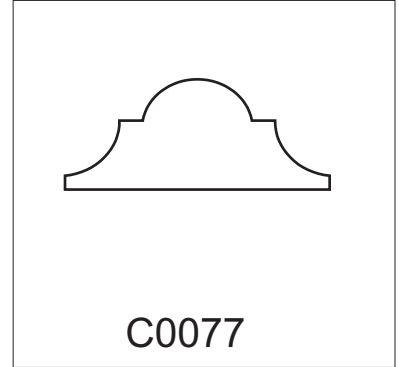
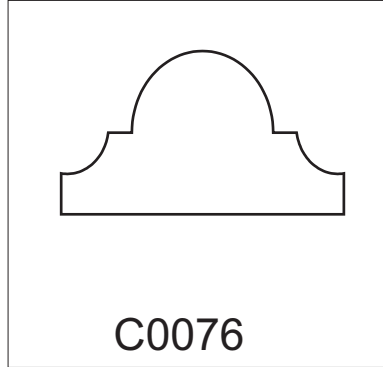
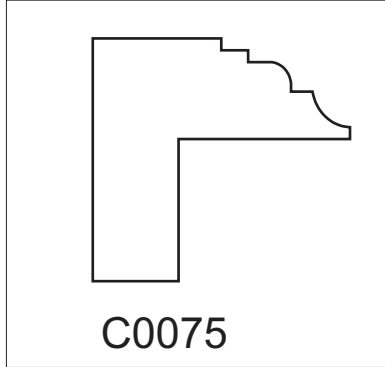

ASTRAGALS 2/4

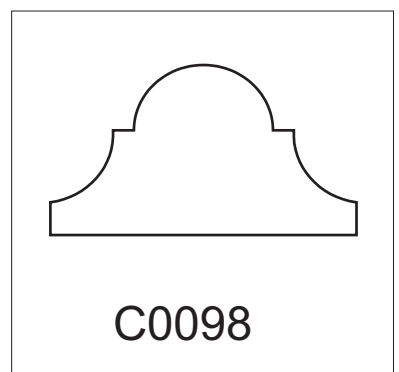
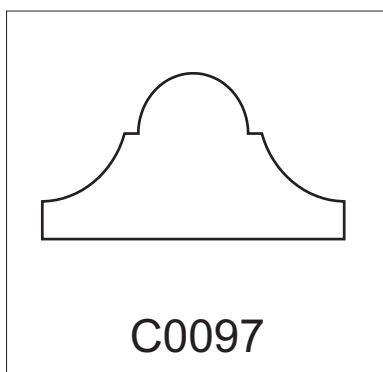
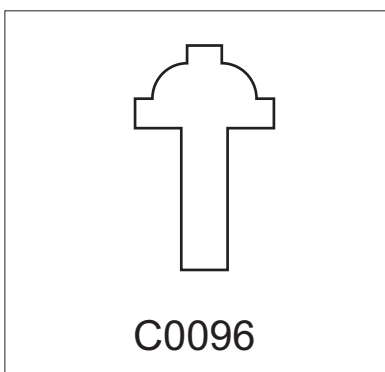
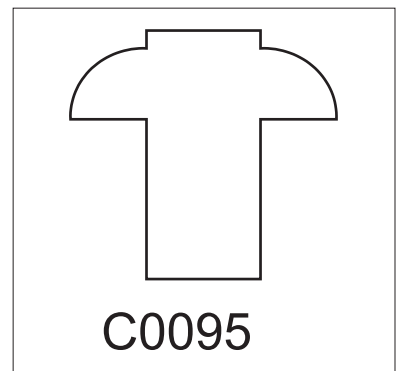
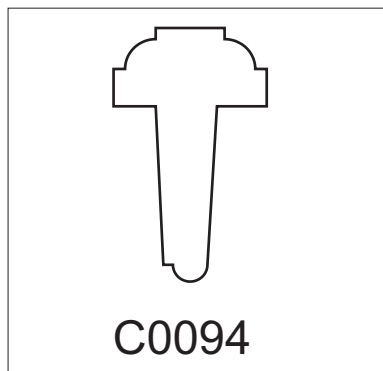
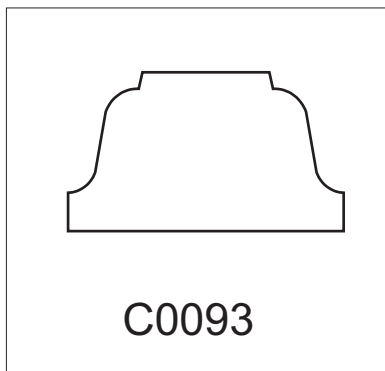
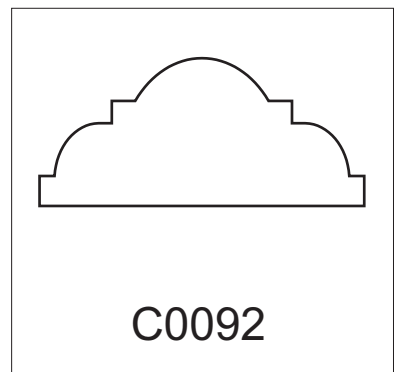
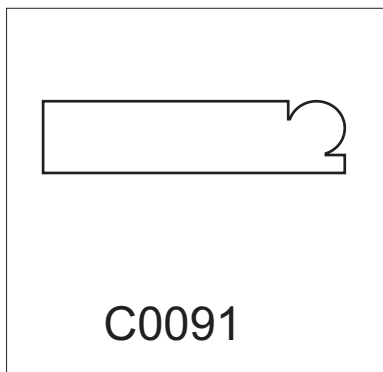
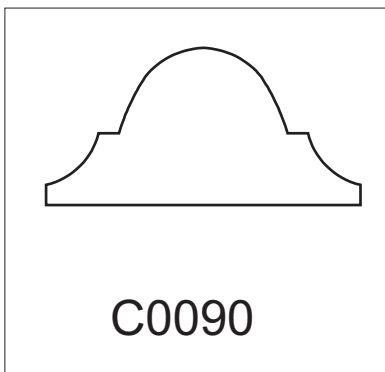
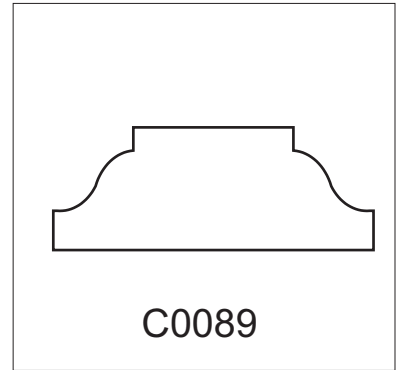
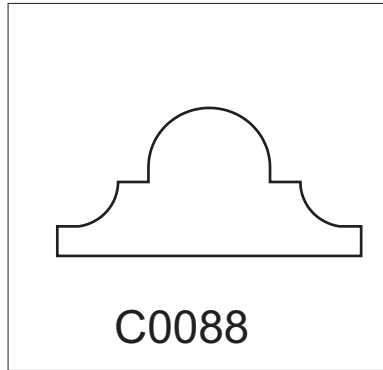
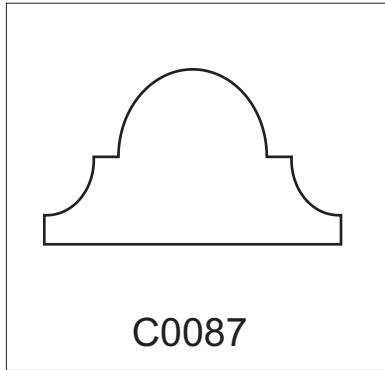

ASTRAGALS 3/4

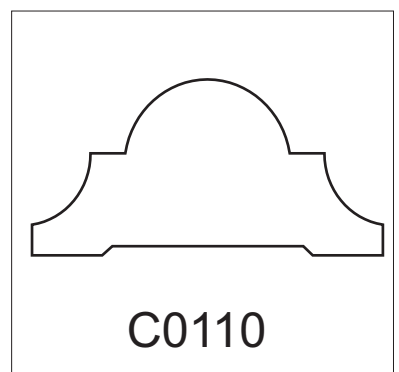
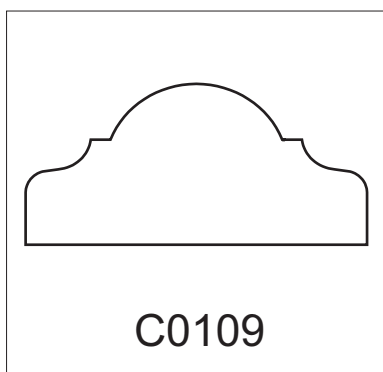
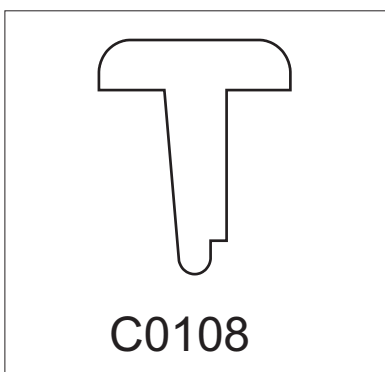
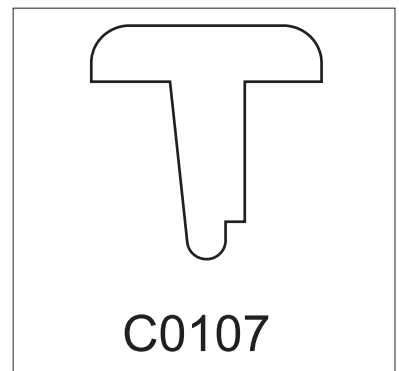
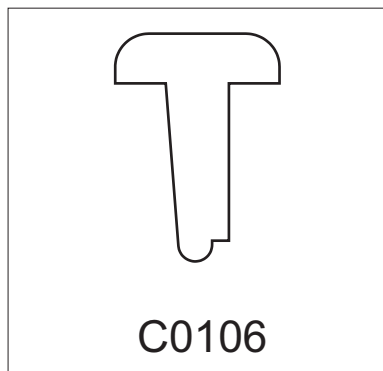
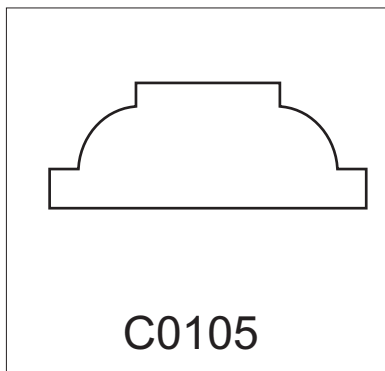
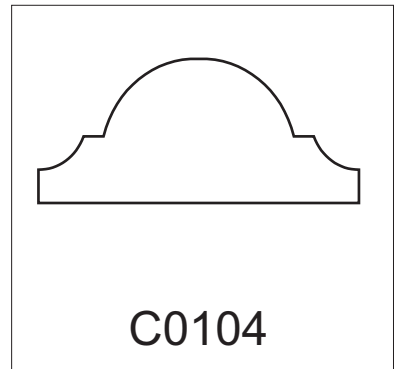
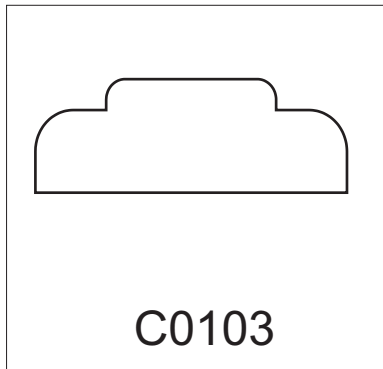
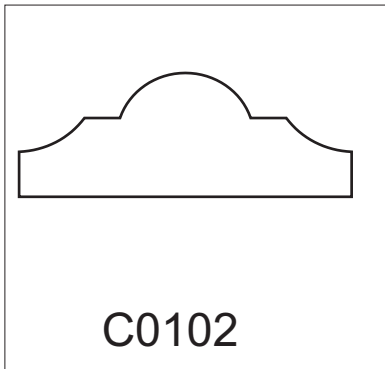
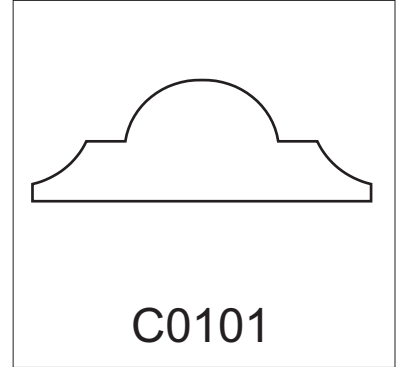
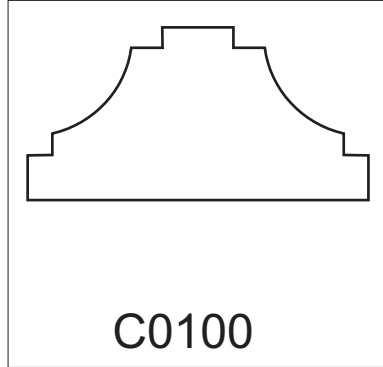
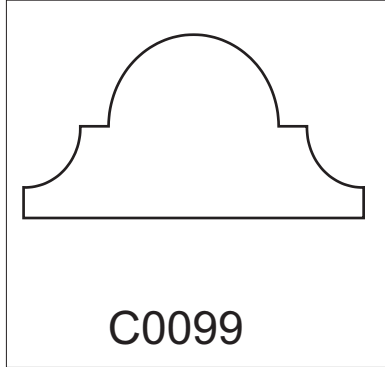

ASTRAGALS 4/4

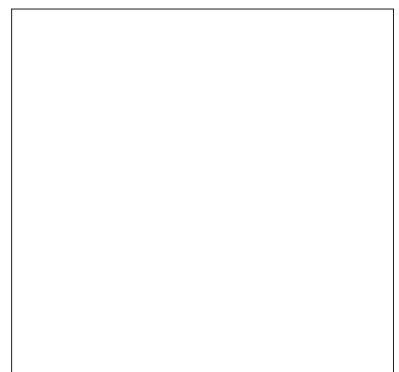
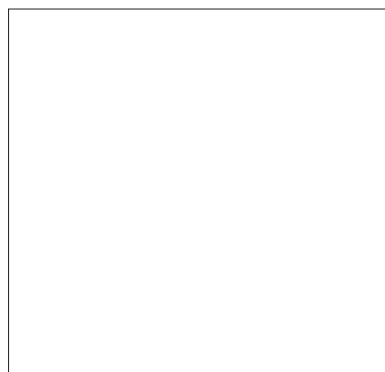
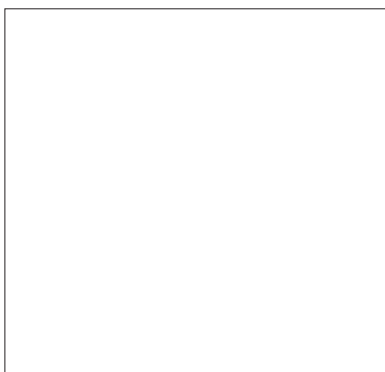
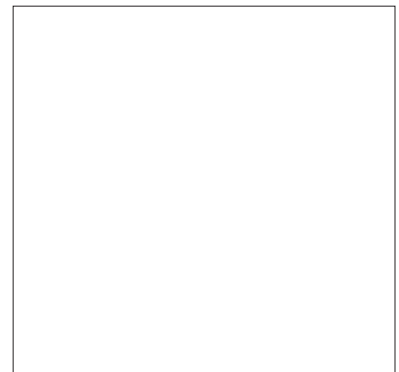
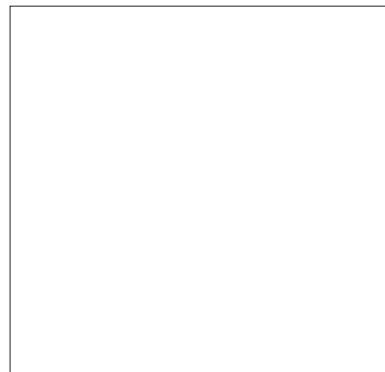
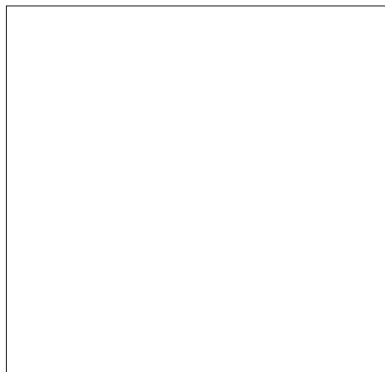
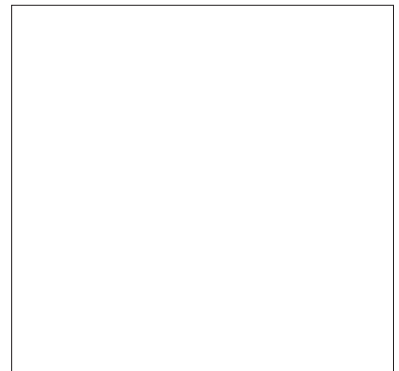
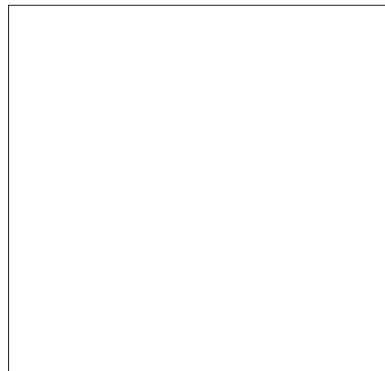
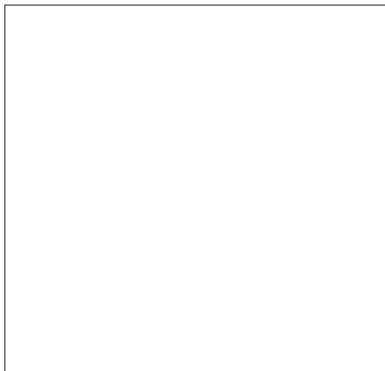
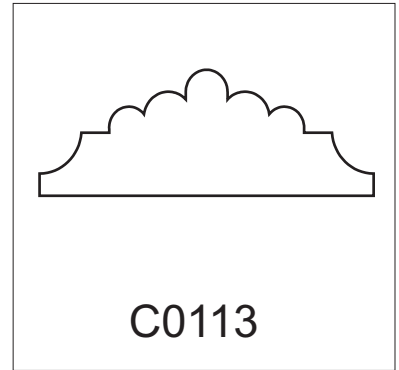
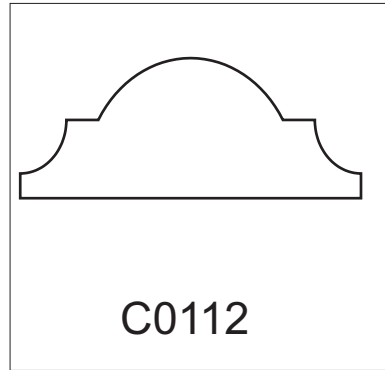
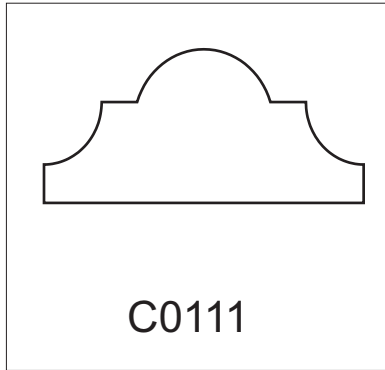

BACK BANDS 1/9

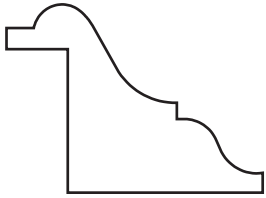

C0114

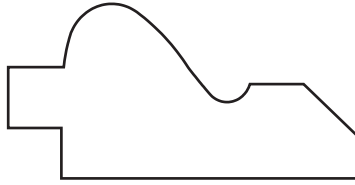

C0115

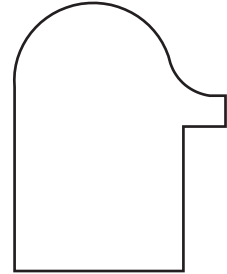

C0116

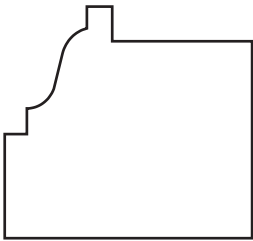

C0117

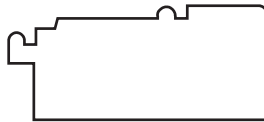

C0118

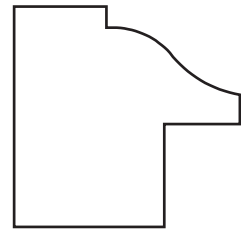

C0119

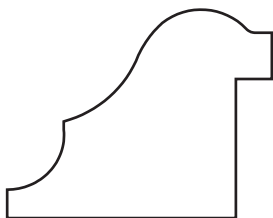

C0120

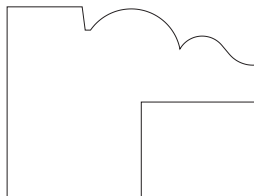

C0121

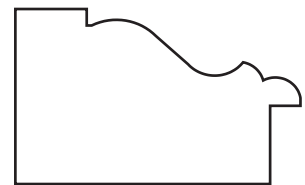

C0122

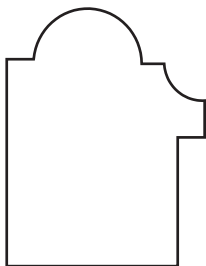

C0123



C0124



C0125

BACK BANDS 3/9

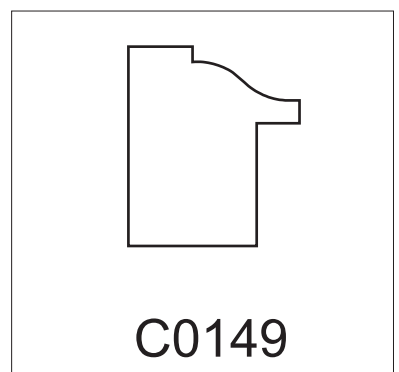
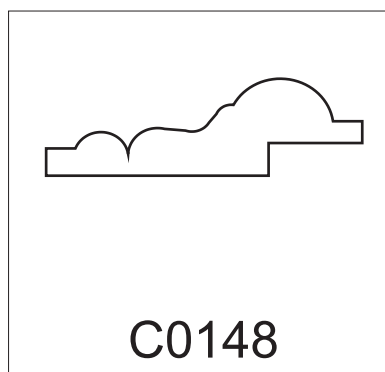
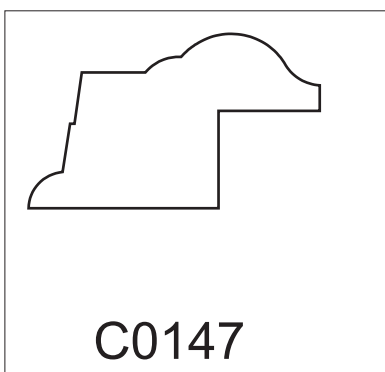
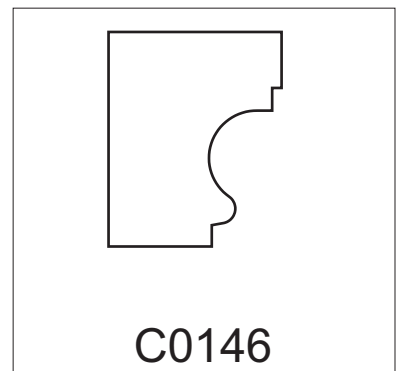
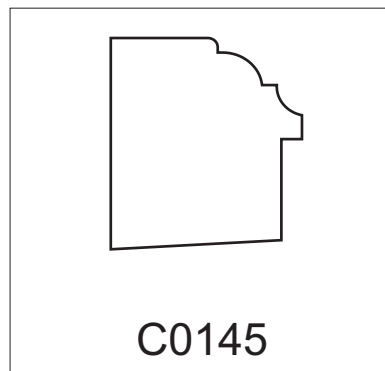
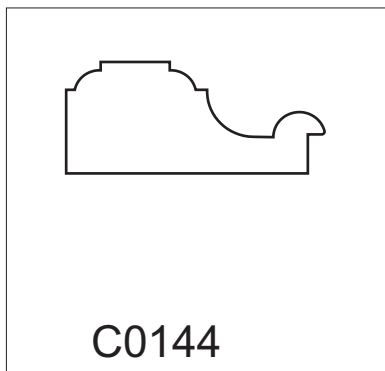
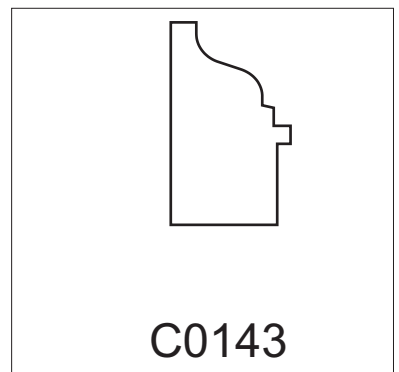
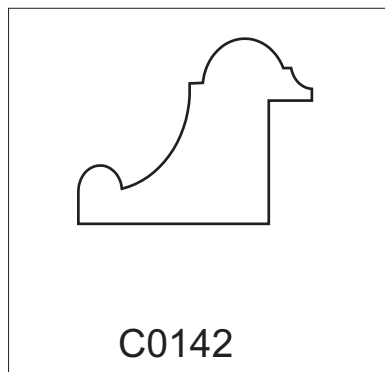
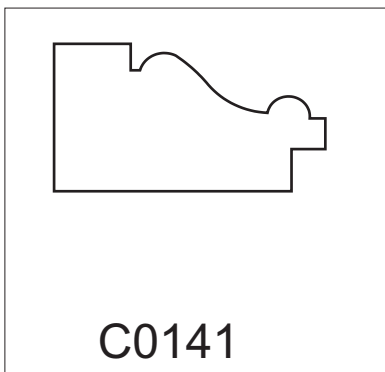
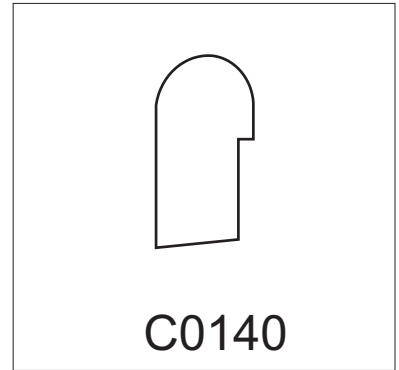
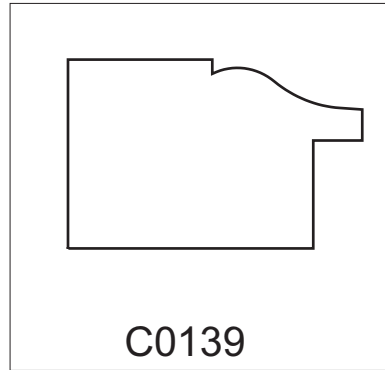
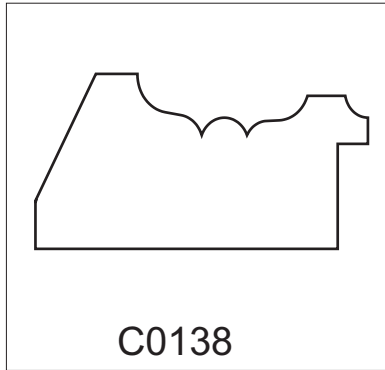

BACK BANDS 4/9

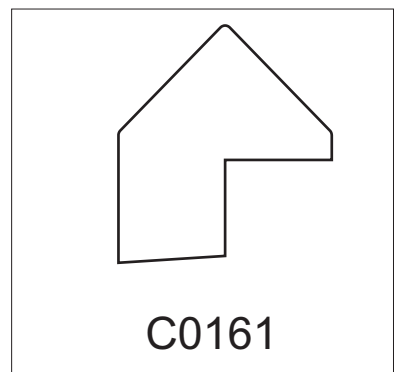
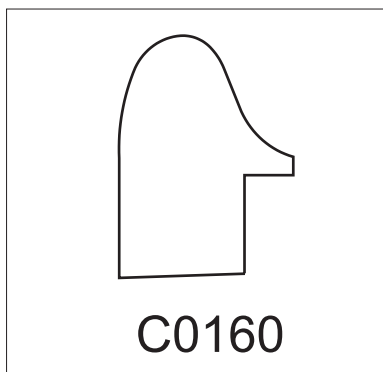
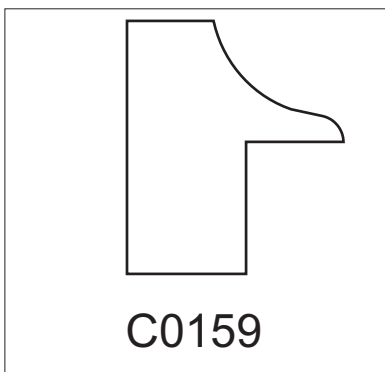
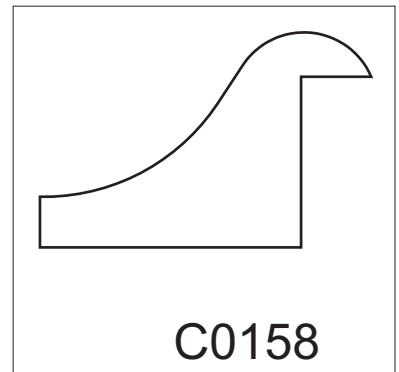
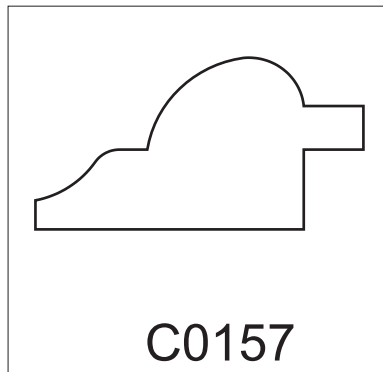
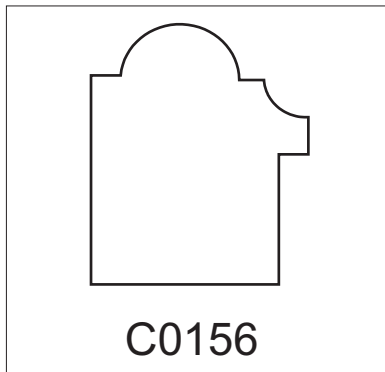
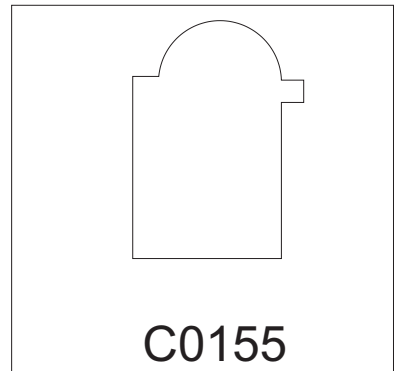
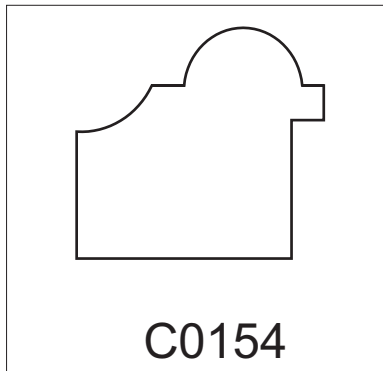
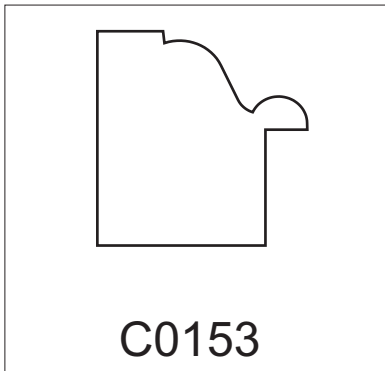
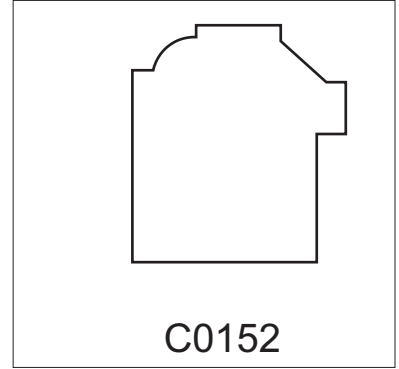
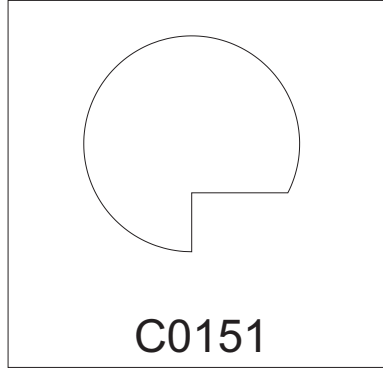
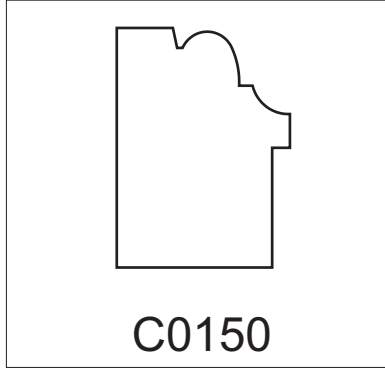

BACK BANDS 5/9

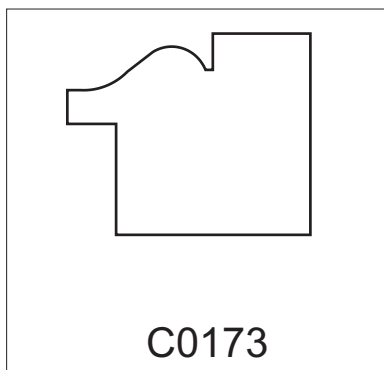
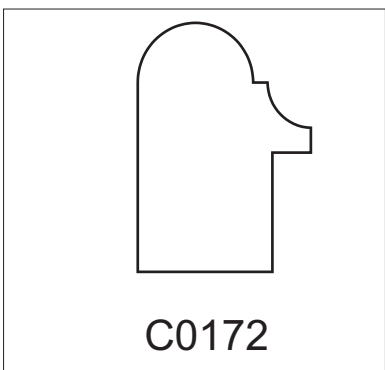
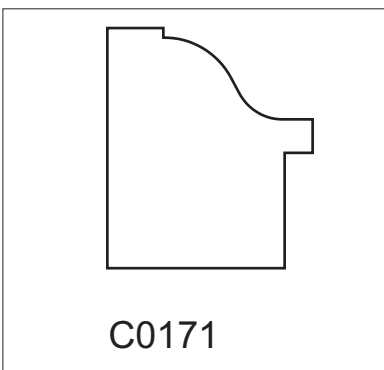
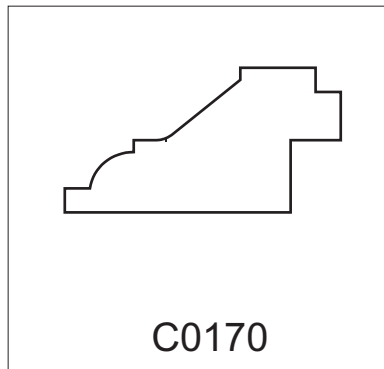
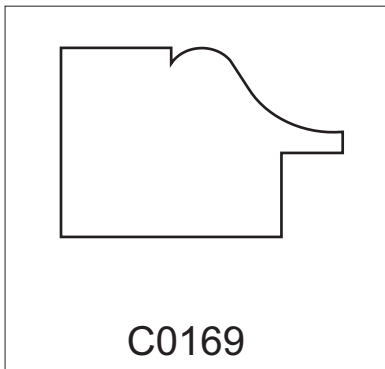
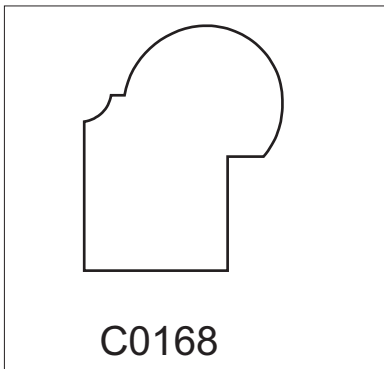
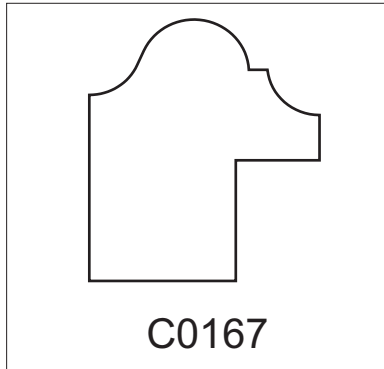
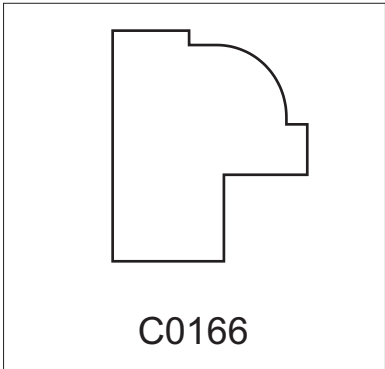
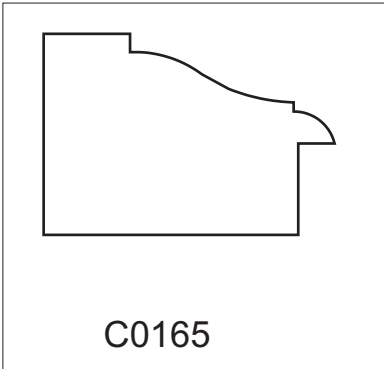
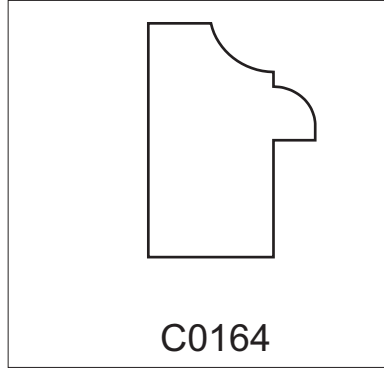
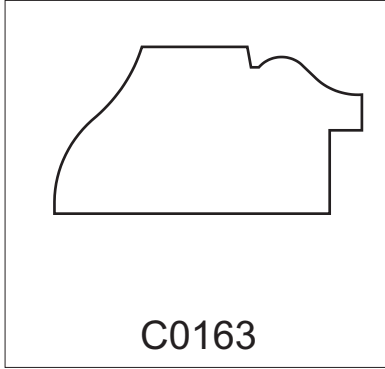
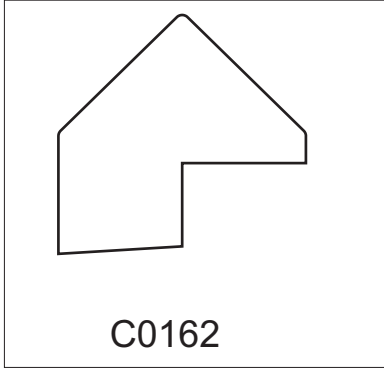

BACK BANDS 6/9

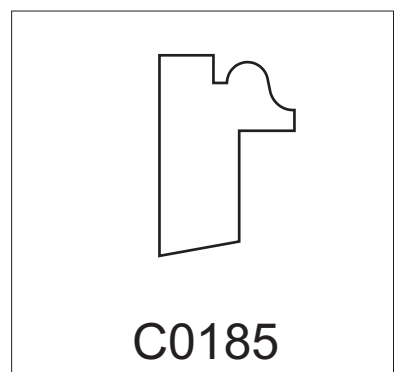
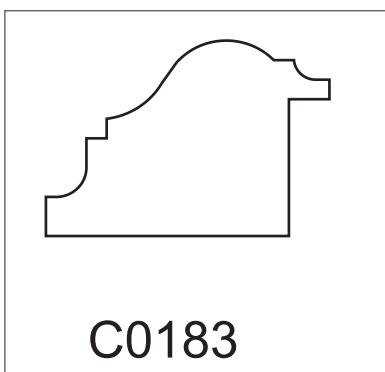
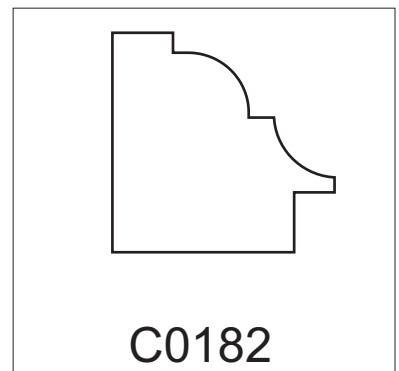
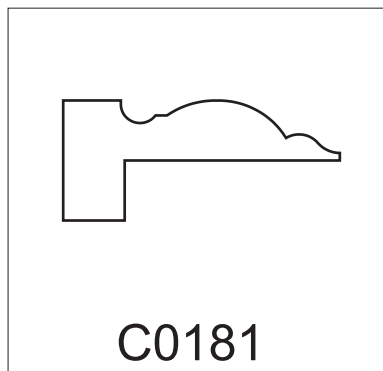
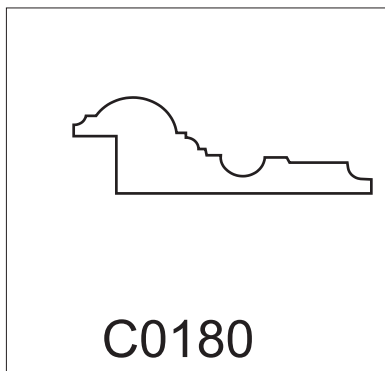
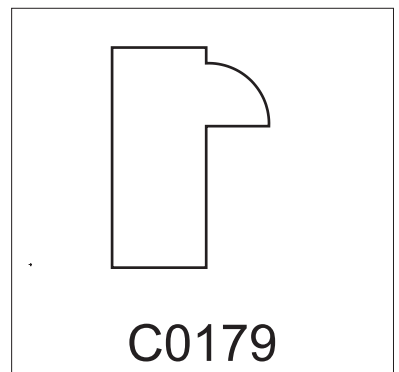
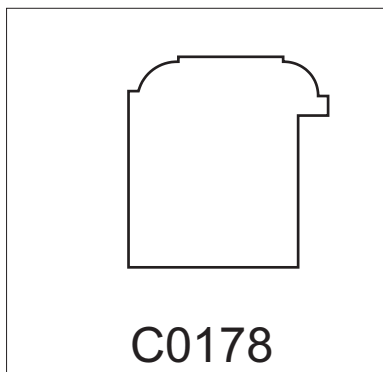
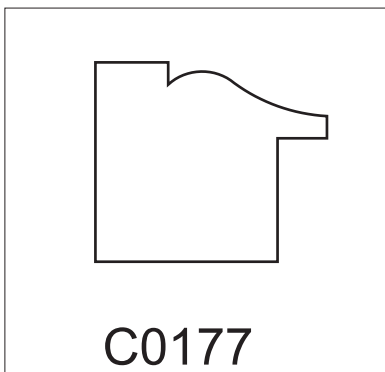
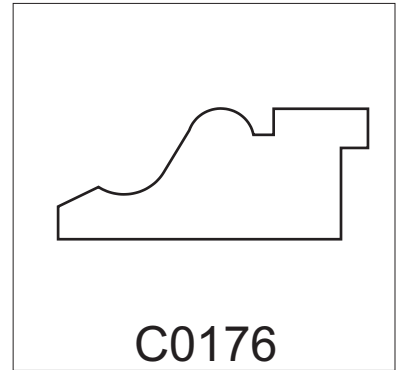
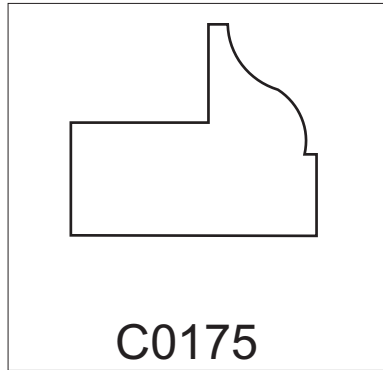
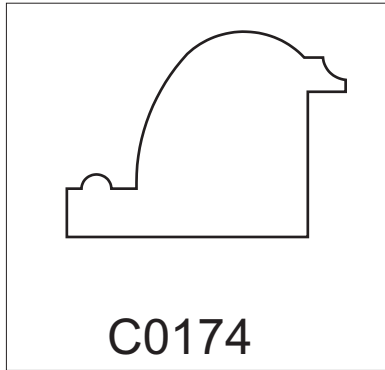

BACK BANDS 7/9

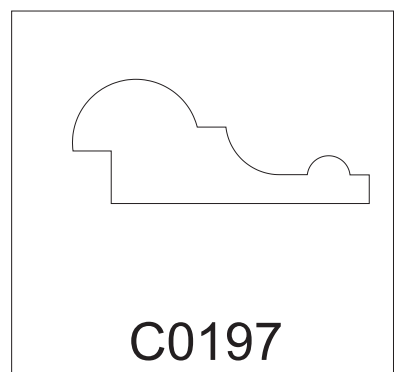
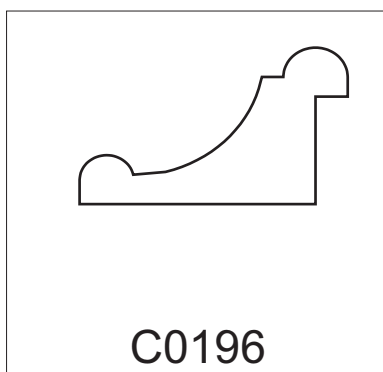
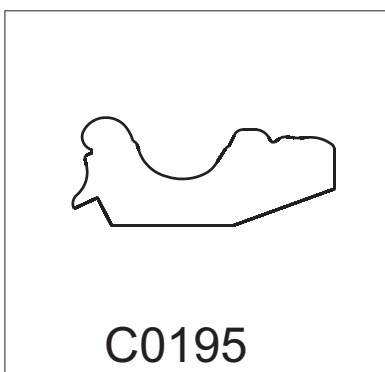
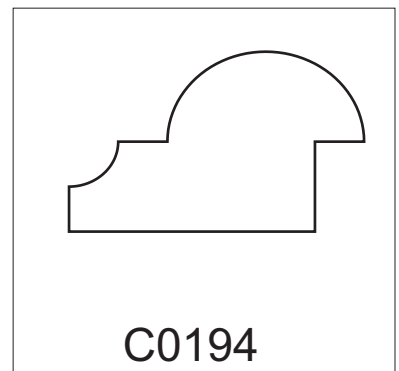
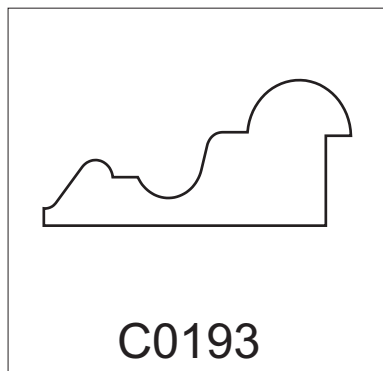
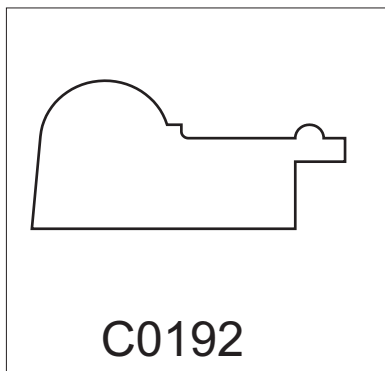
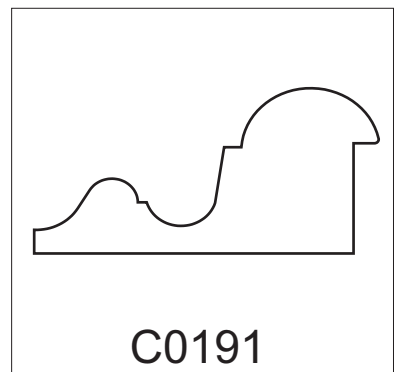
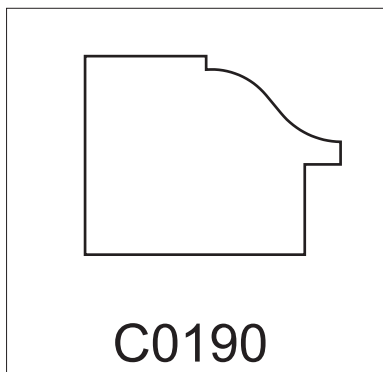
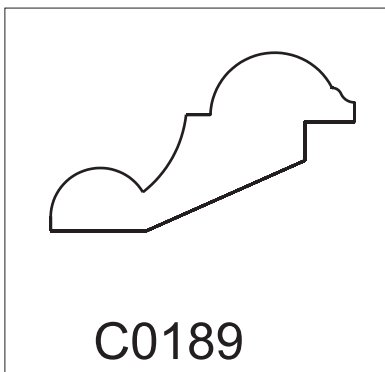
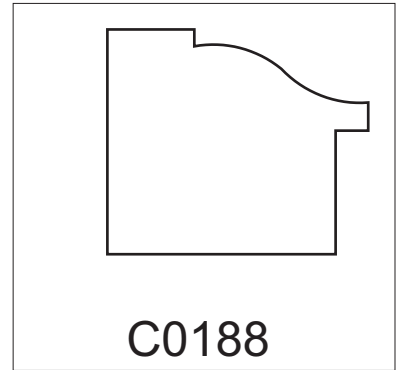
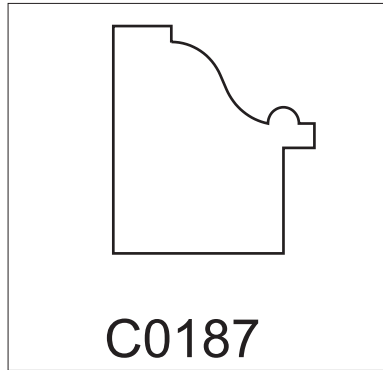
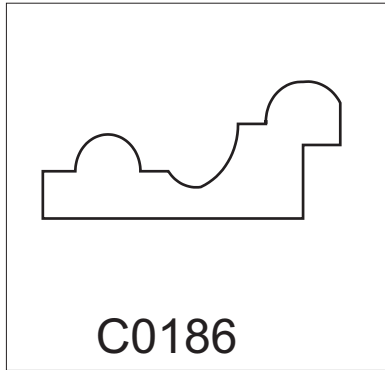

BACK BANDS 8/9

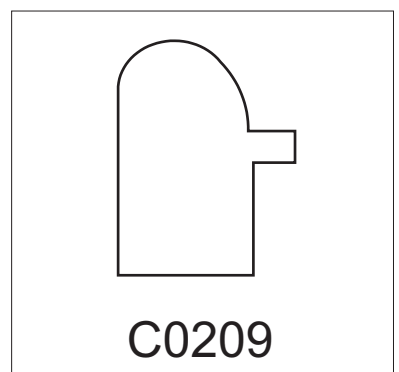
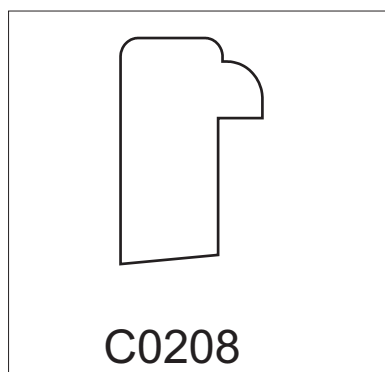
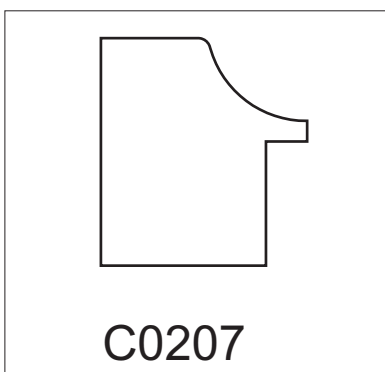
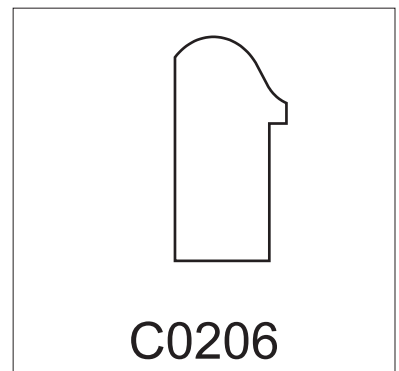
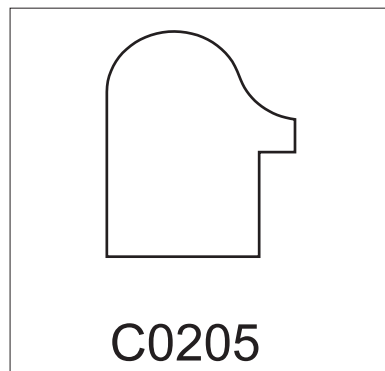
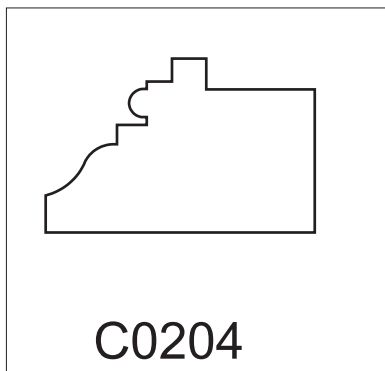
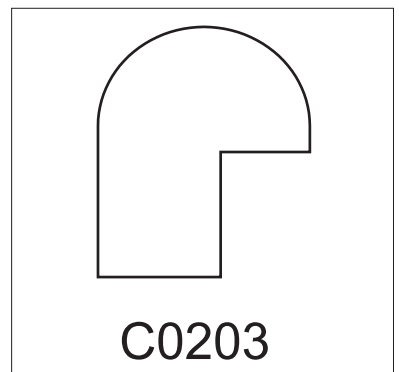
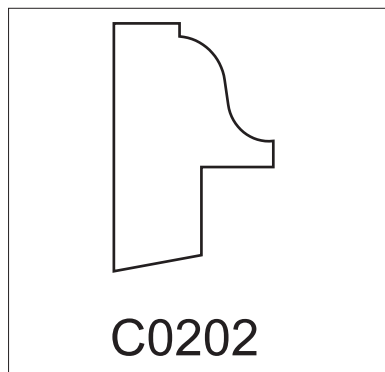
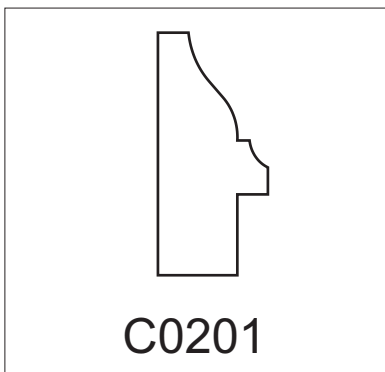
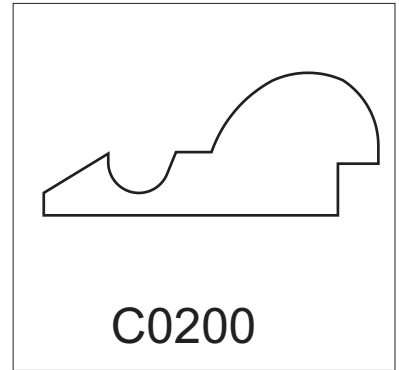
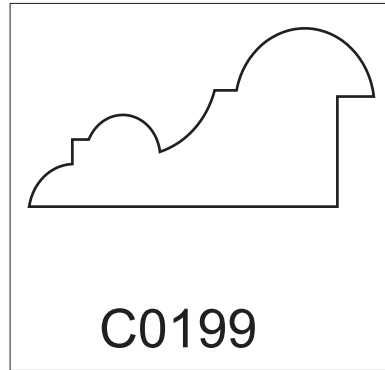
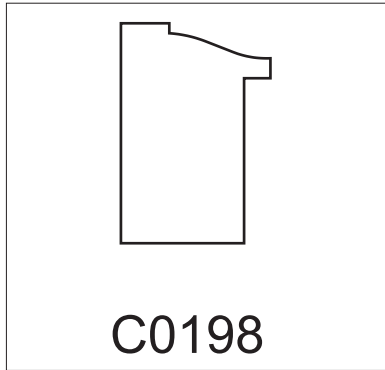

BACK BANDS 9/9

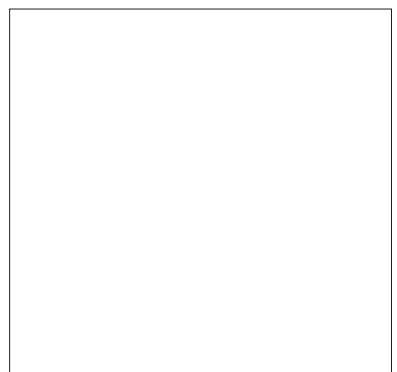
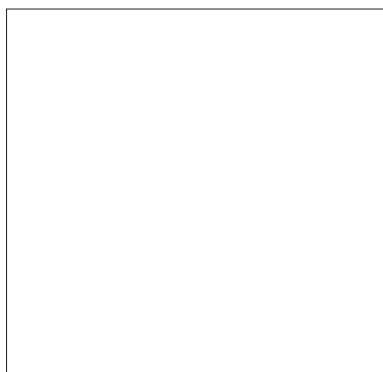
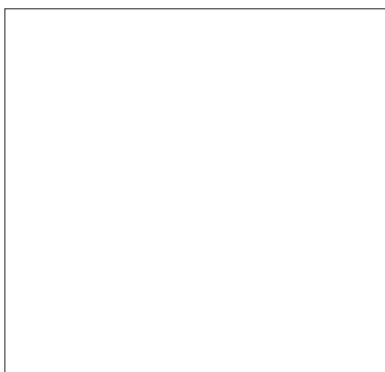
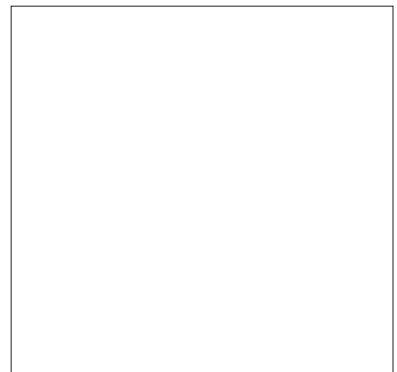
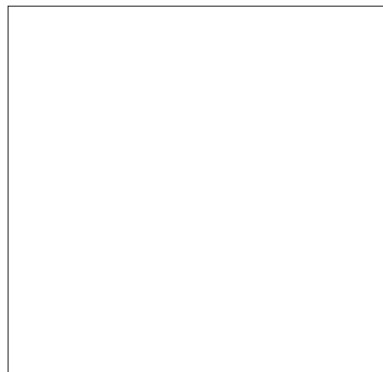
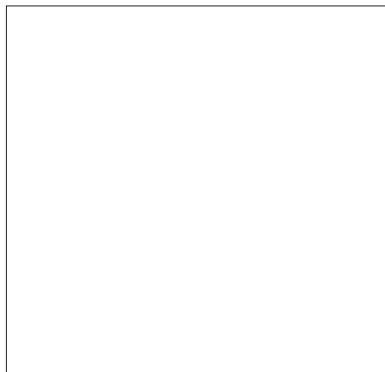
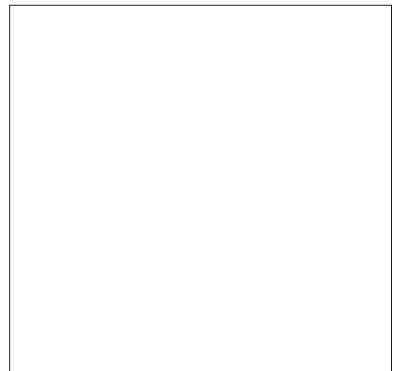
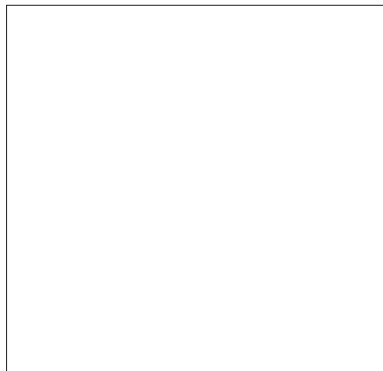
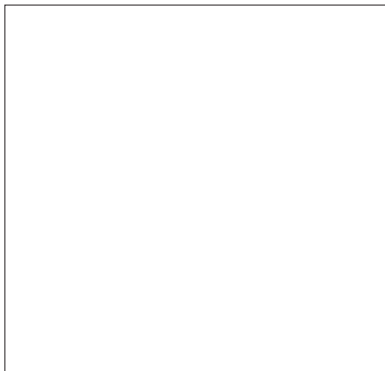
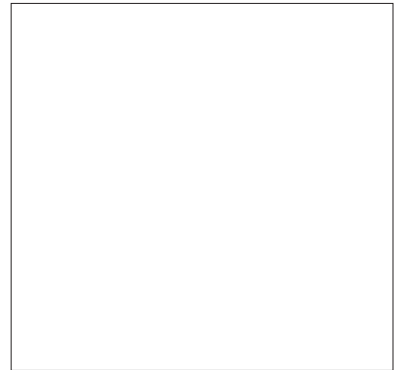
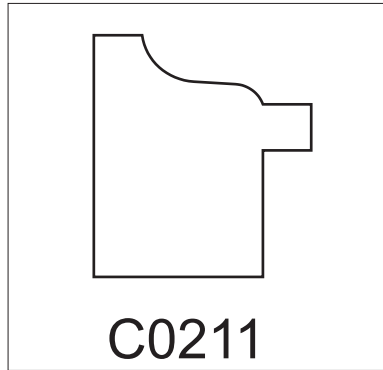
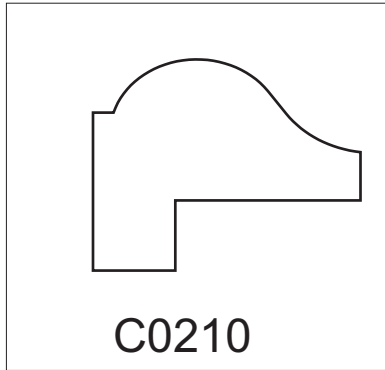

BANDS 1/7

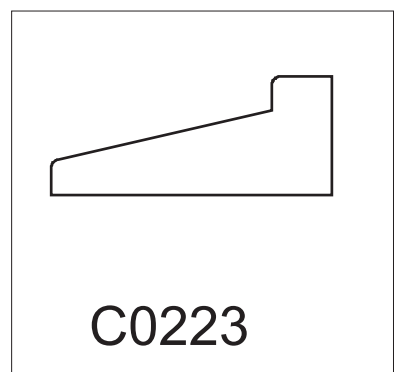
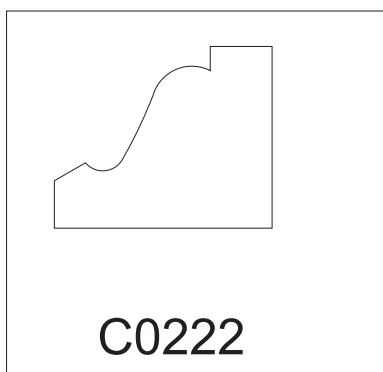
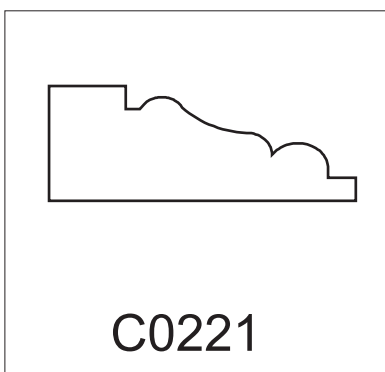
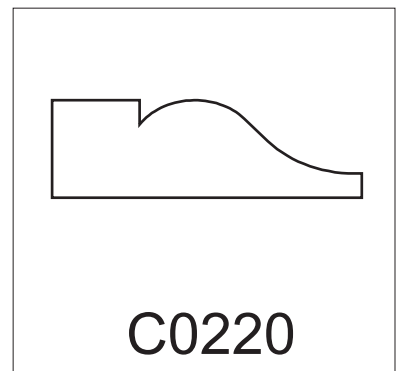
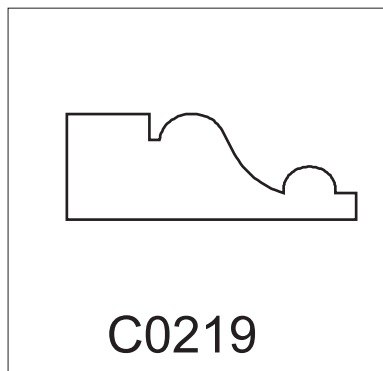
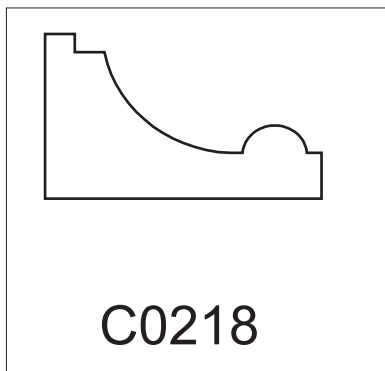
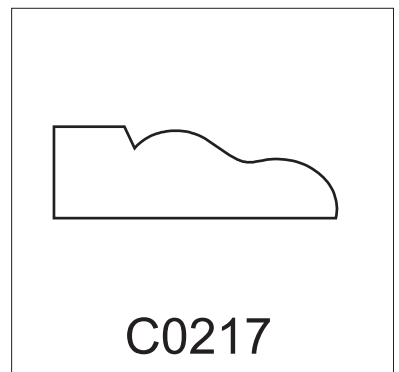
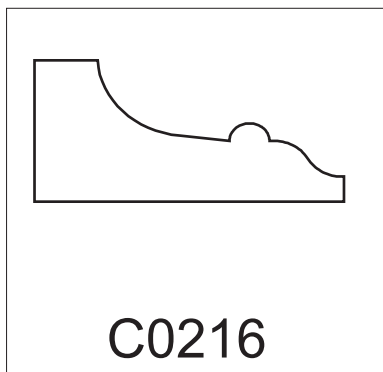
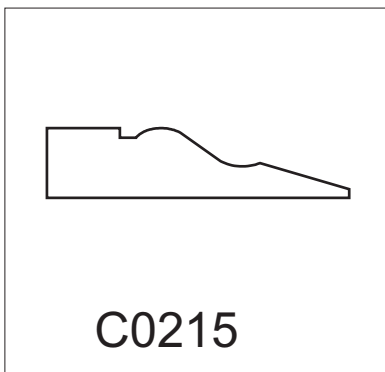
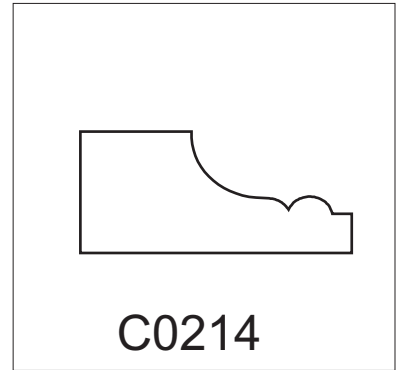
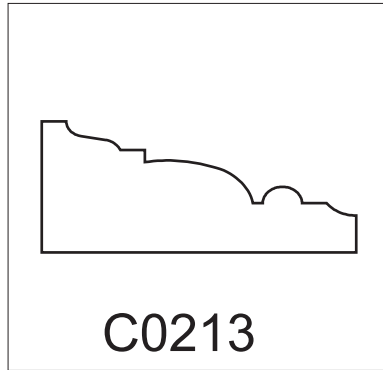
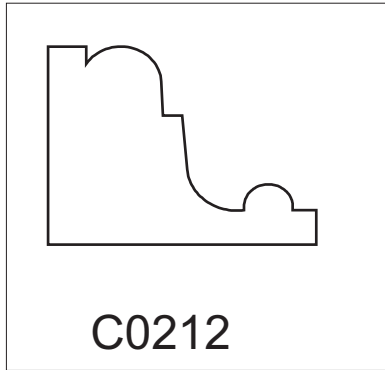

BANDS 2/7

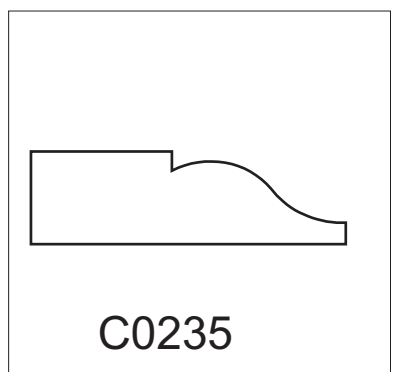
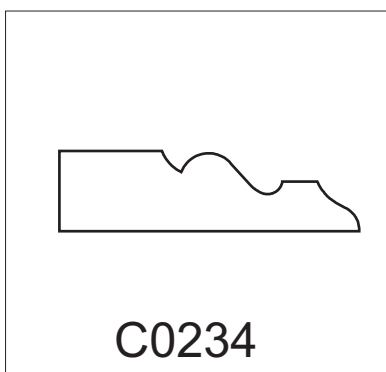
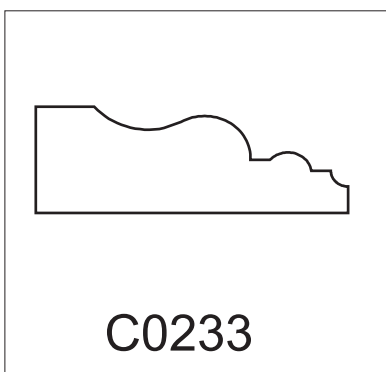
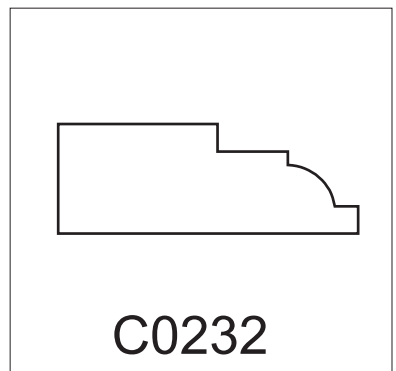
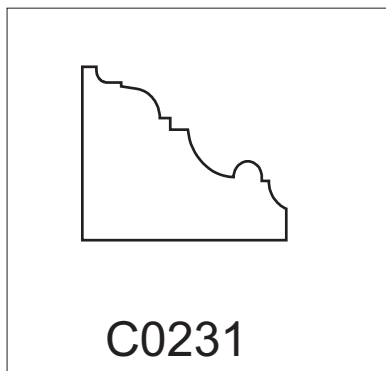
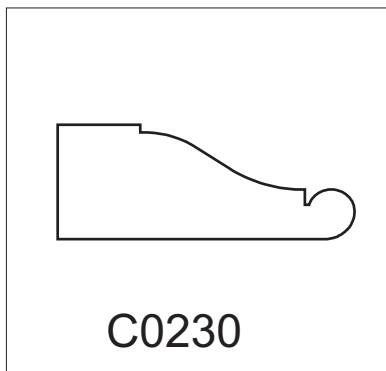
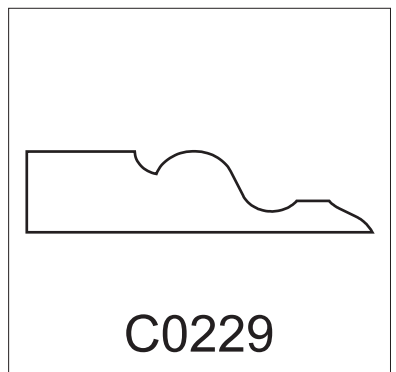
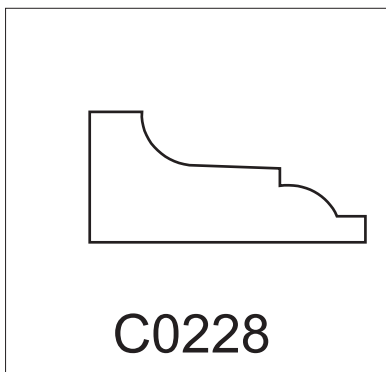
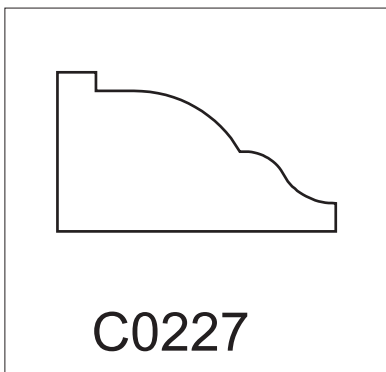
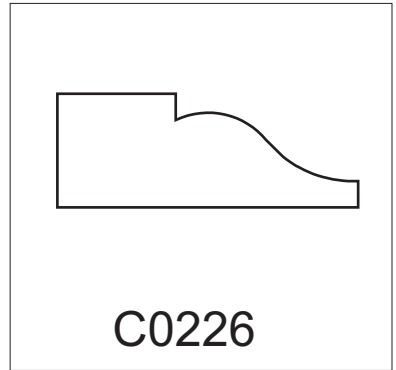
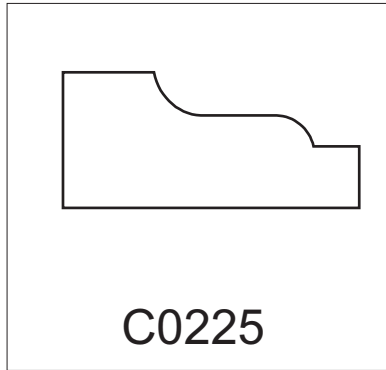
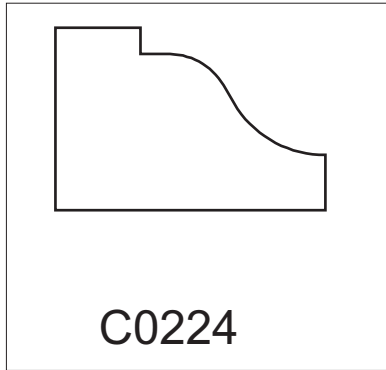

BANDS 3/7

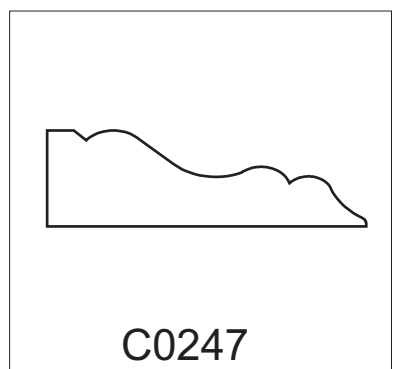
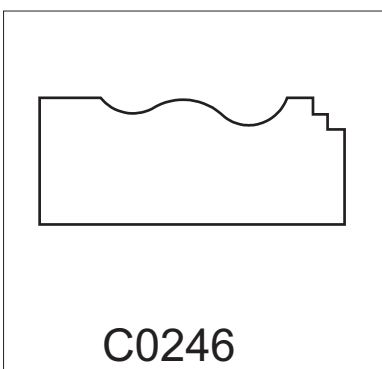
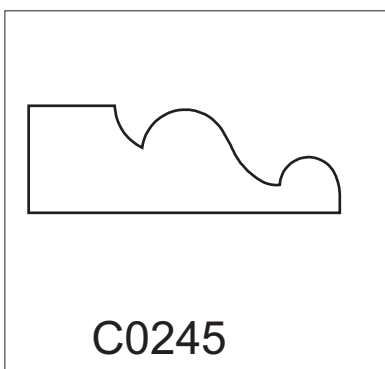
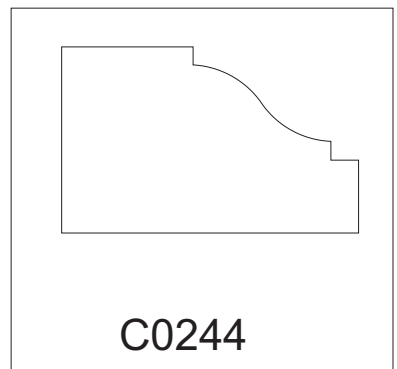
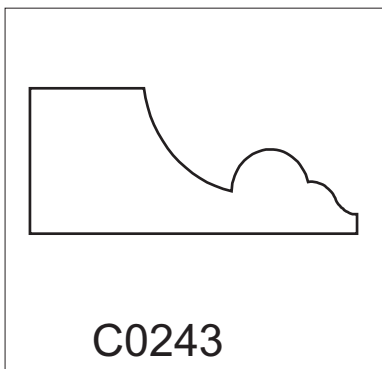
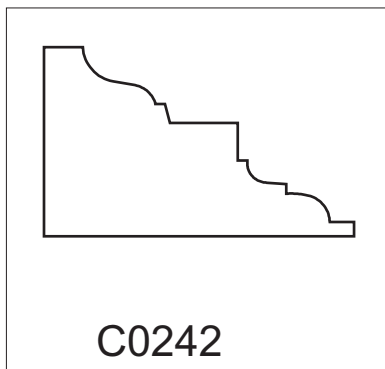
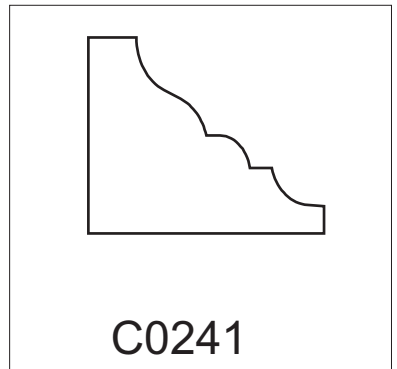
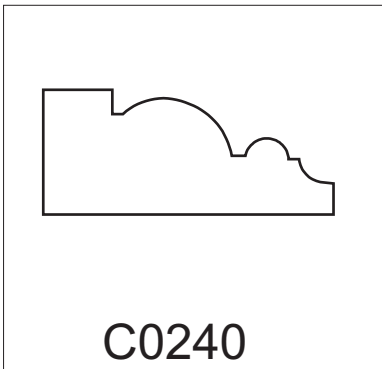
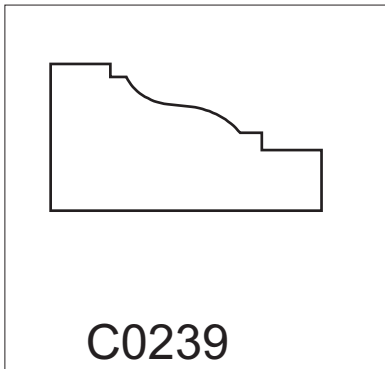
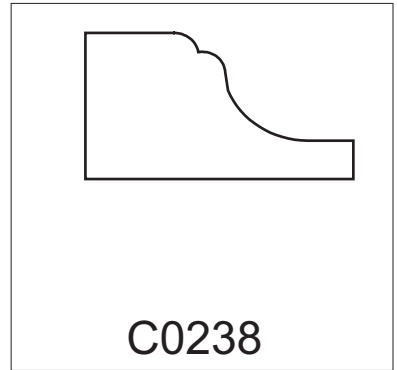
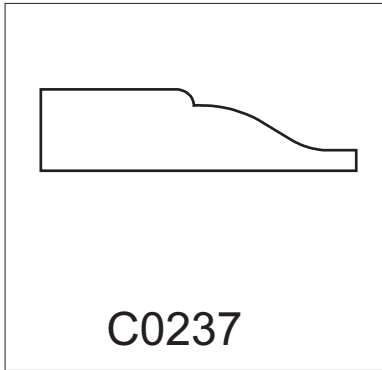
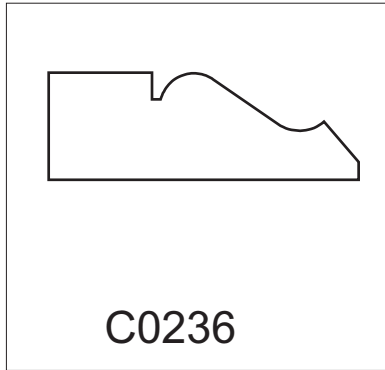

BANDS 4/7

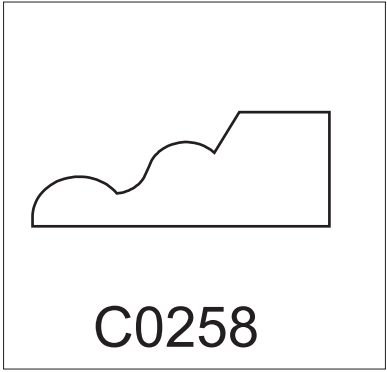
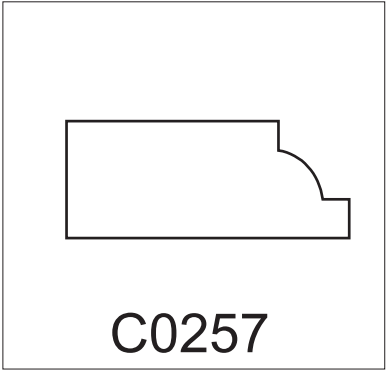
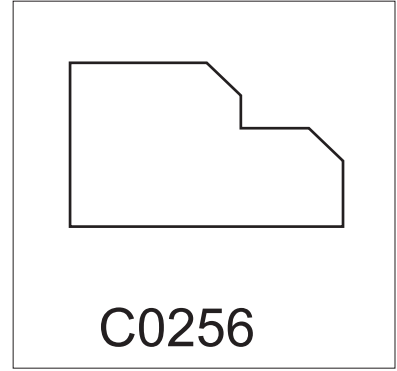
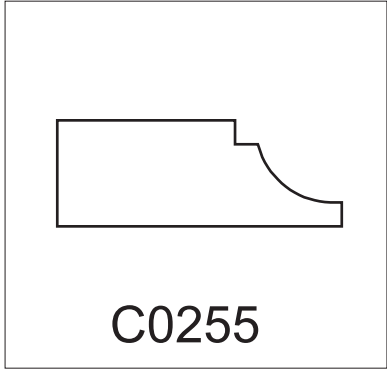
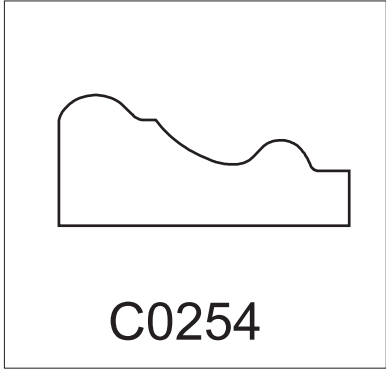
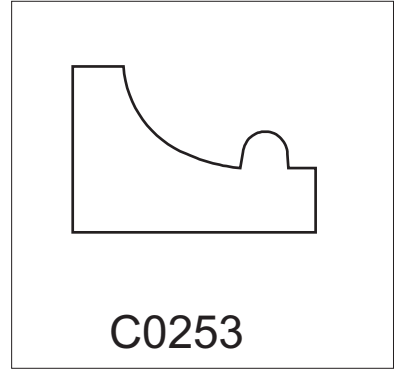
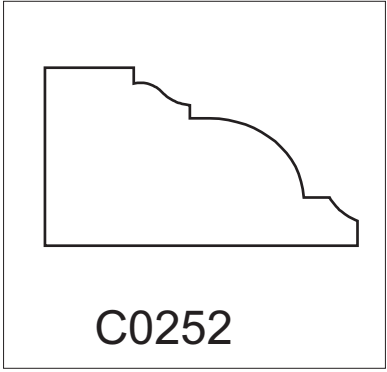
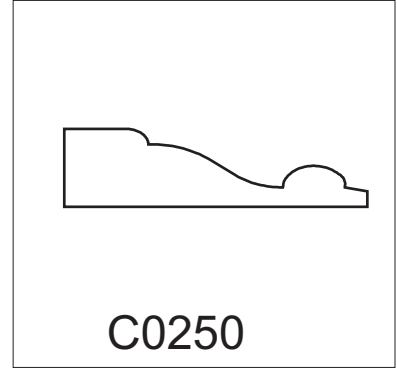
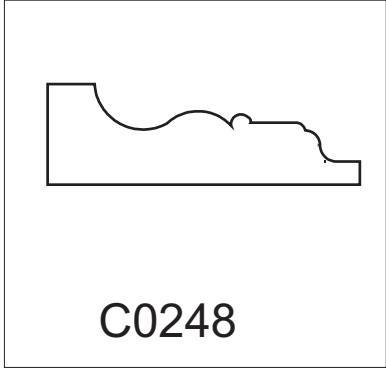

BANDS 5/7

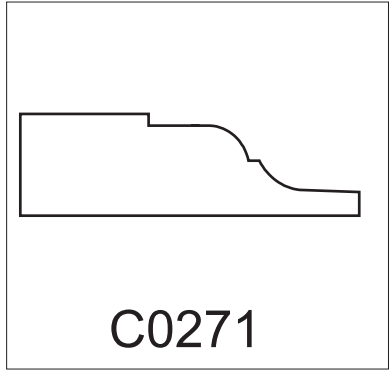
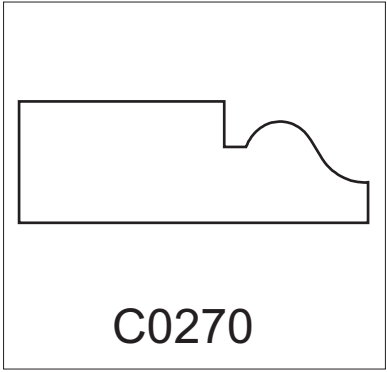
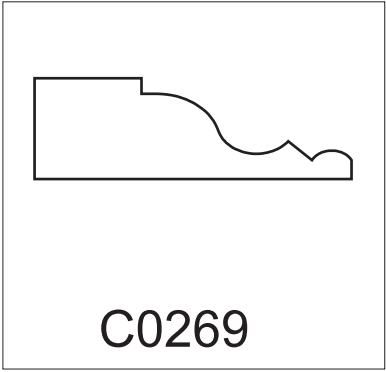
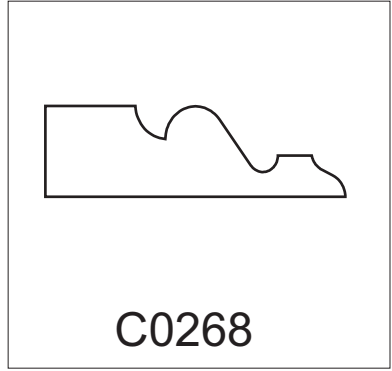
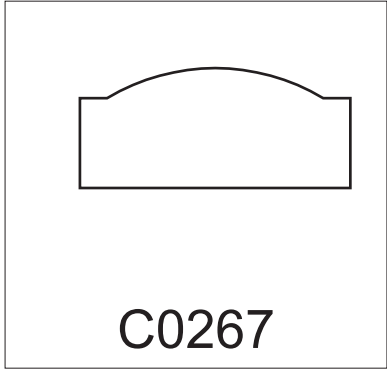
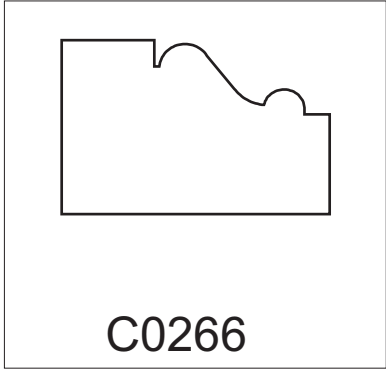
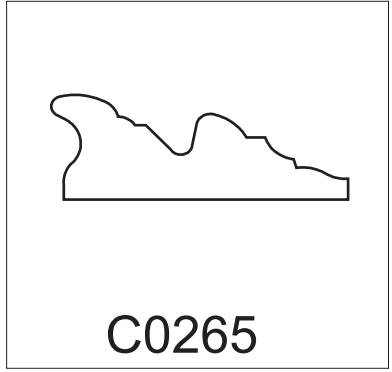
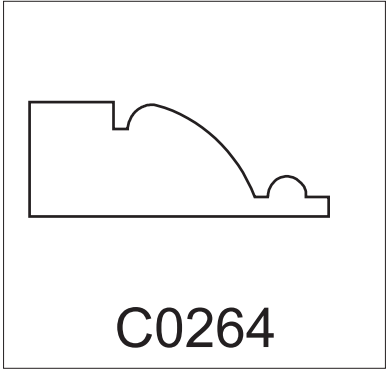
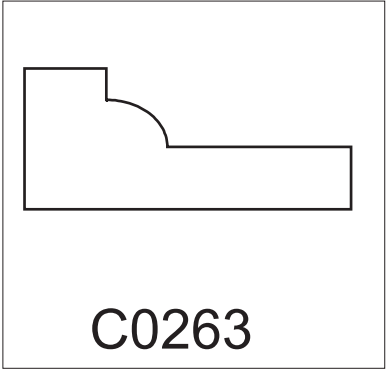
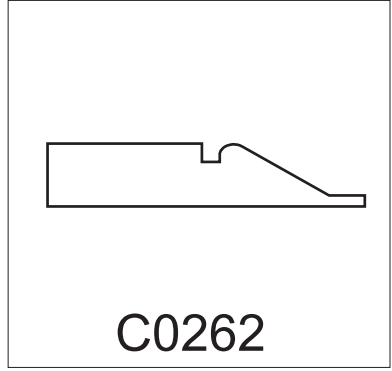
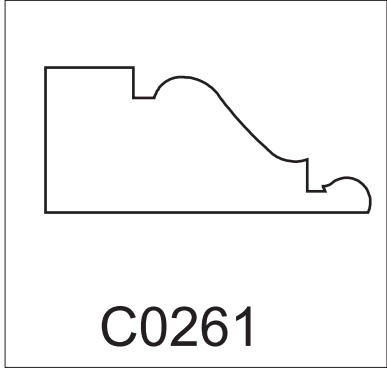
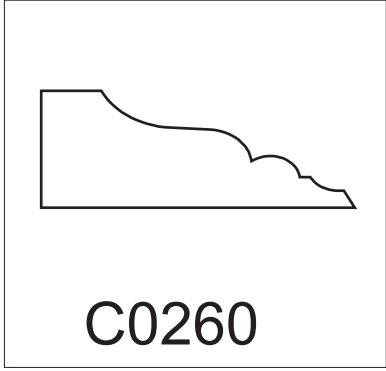

BANDS 6/7

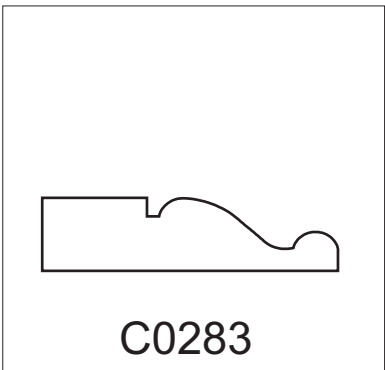
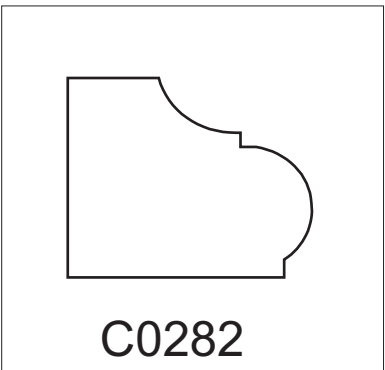
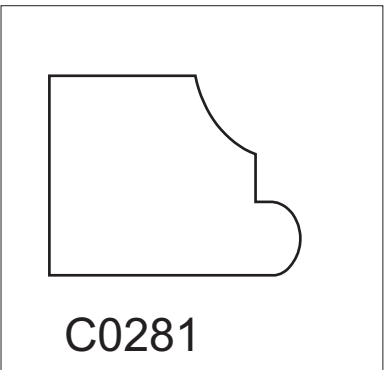
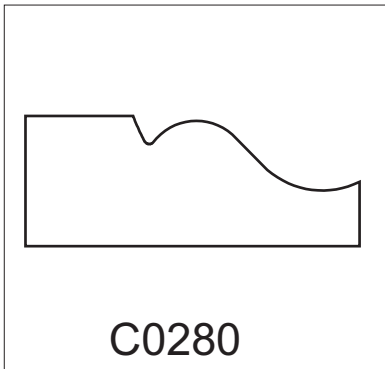
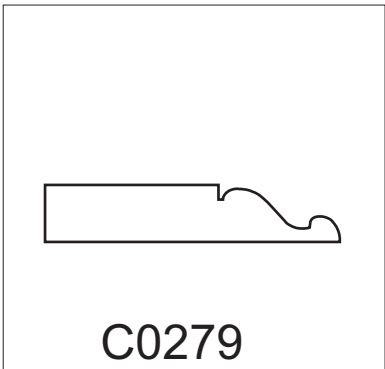
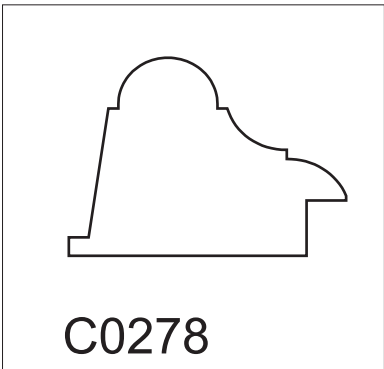
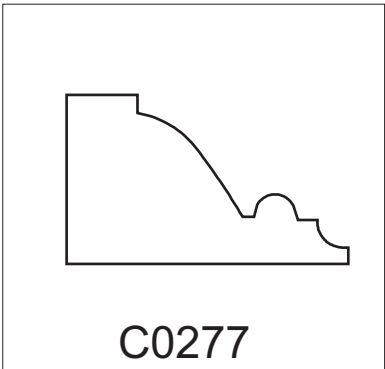
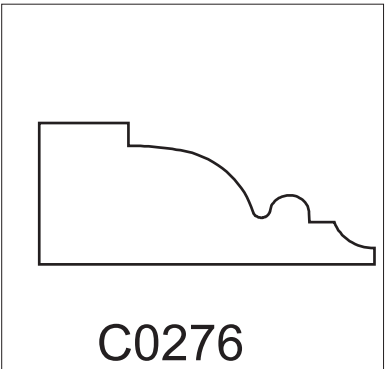
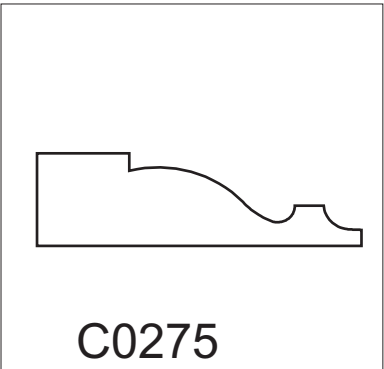
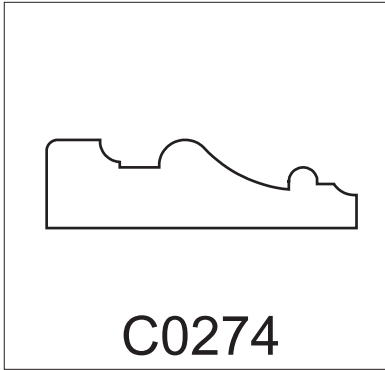
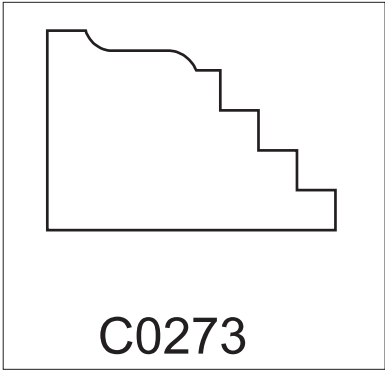
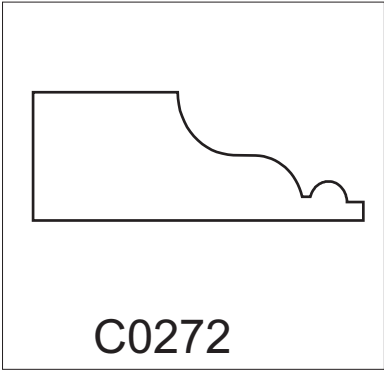

BANDS 7/7

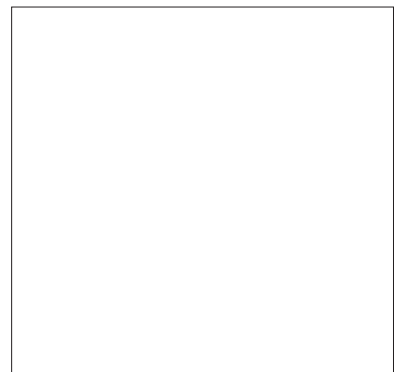
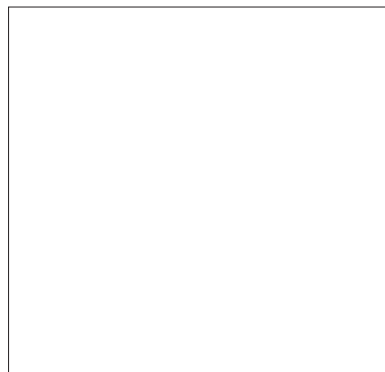
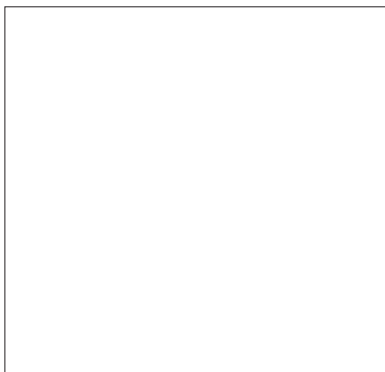
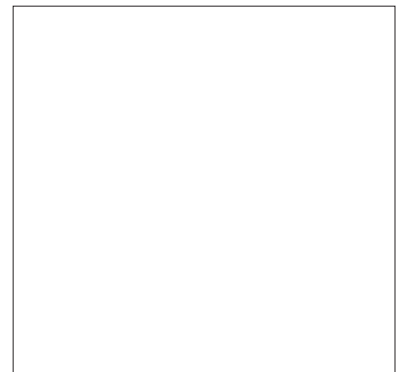
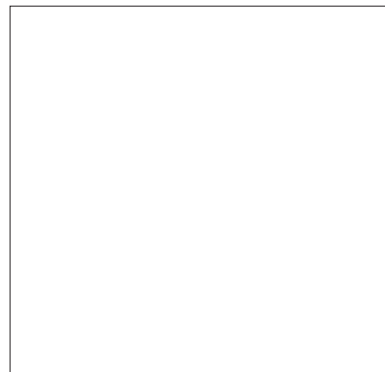
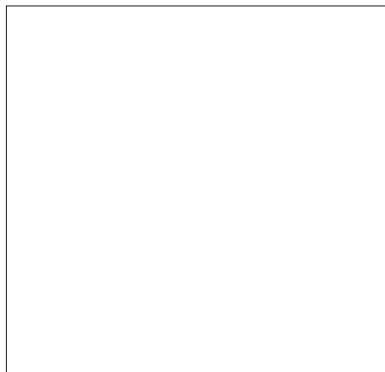
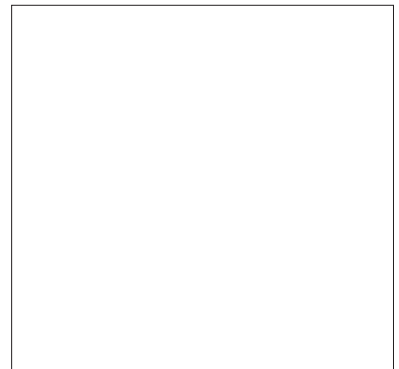
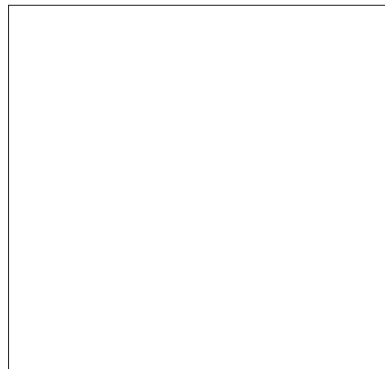
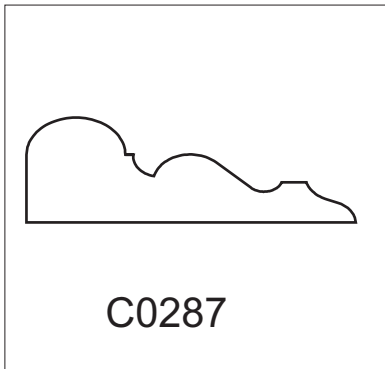
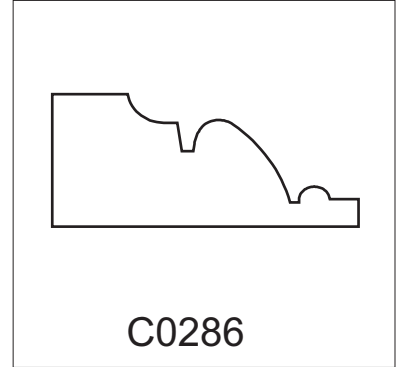
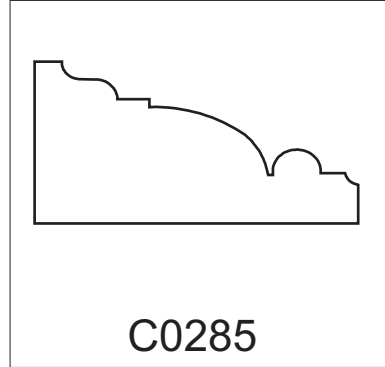
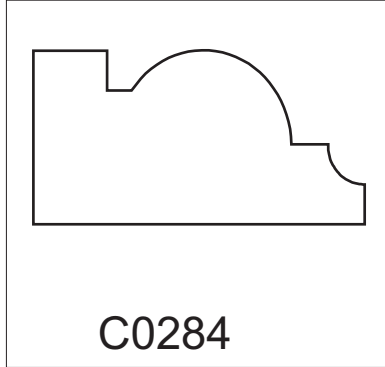

BAR RAILS 1/1

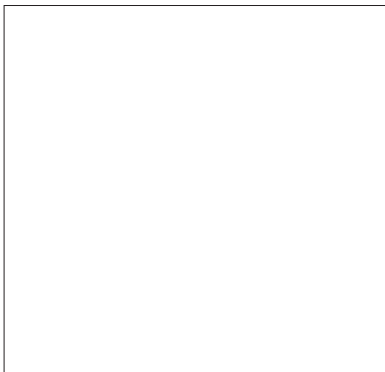
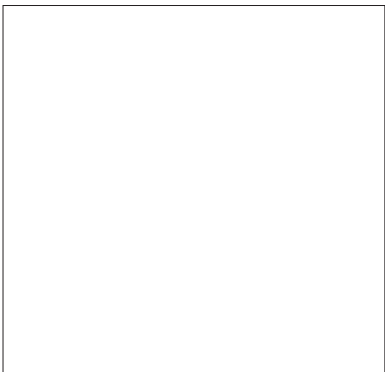
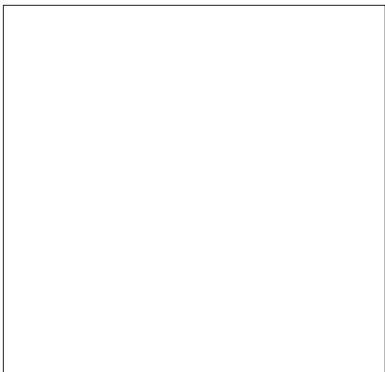
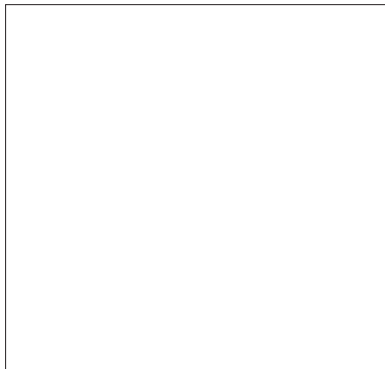
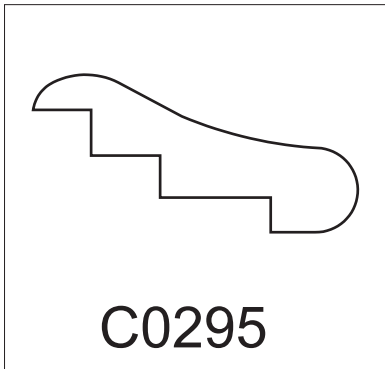
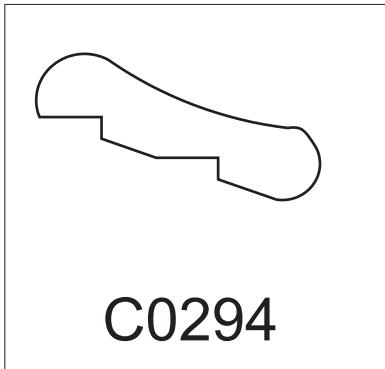
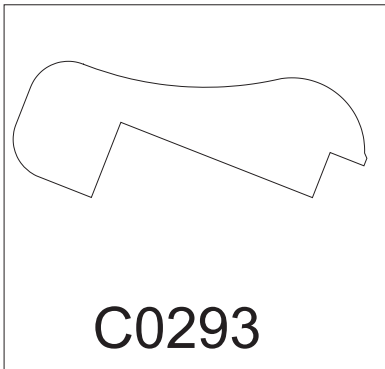
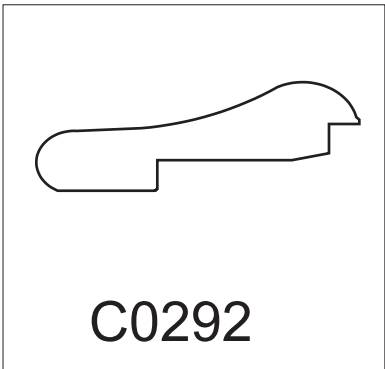
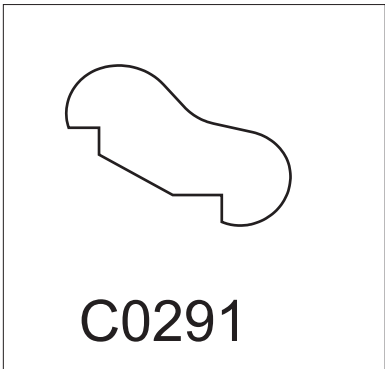
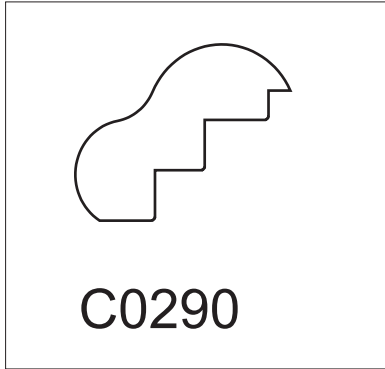
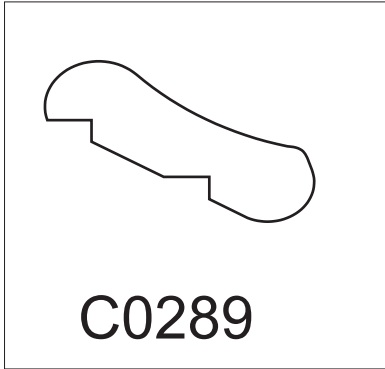
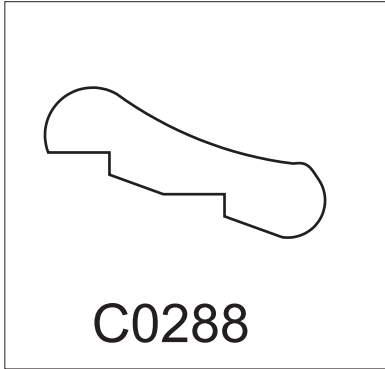

BASE CAPS 1/8

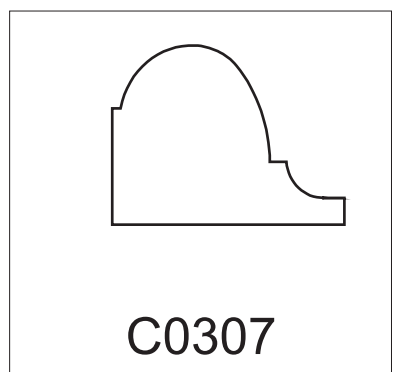
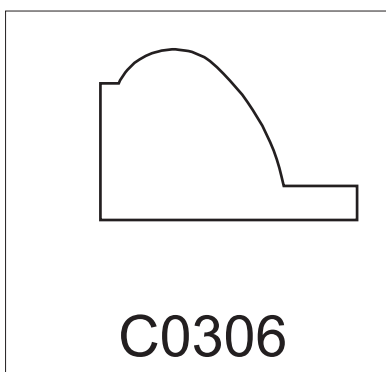
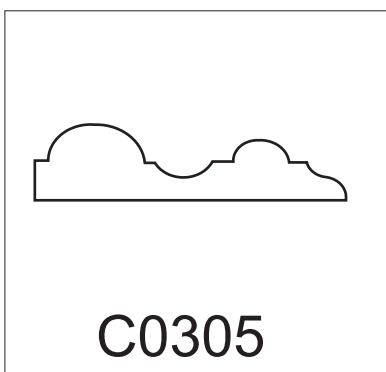
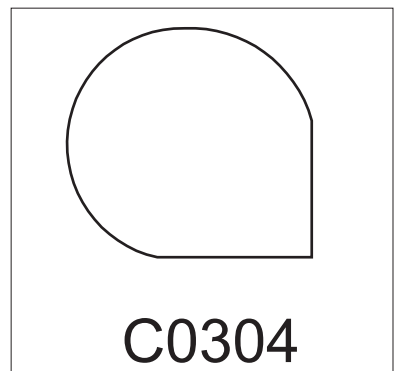
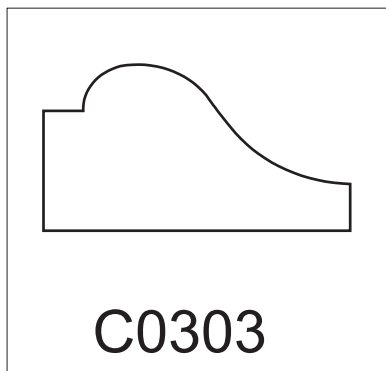
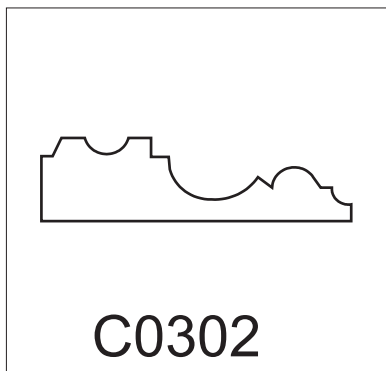
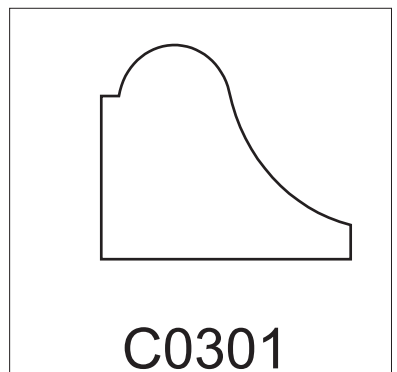
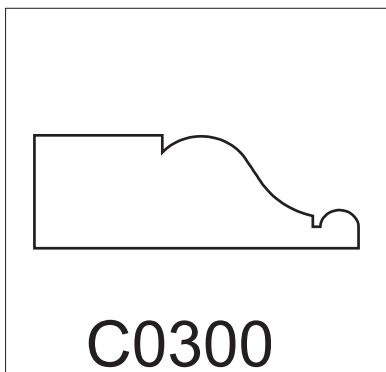
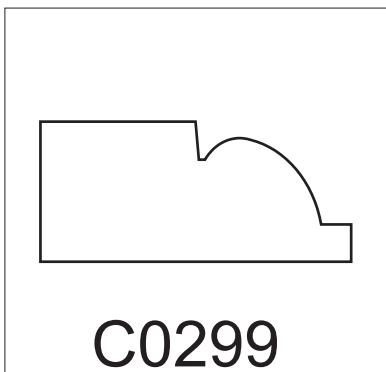
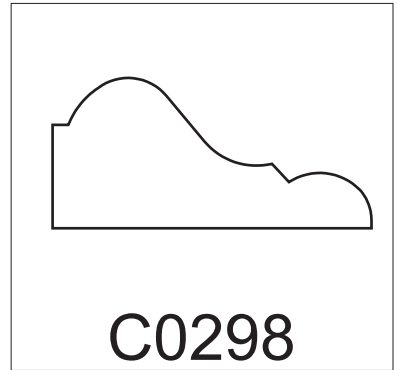
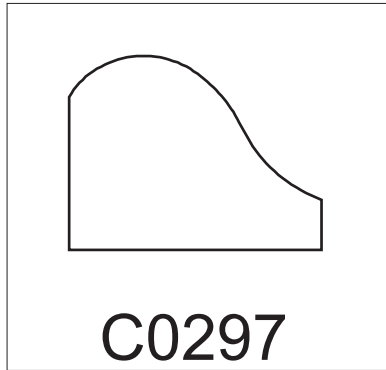
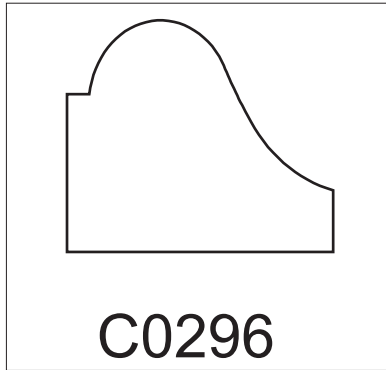

BASE CAPS 2/8

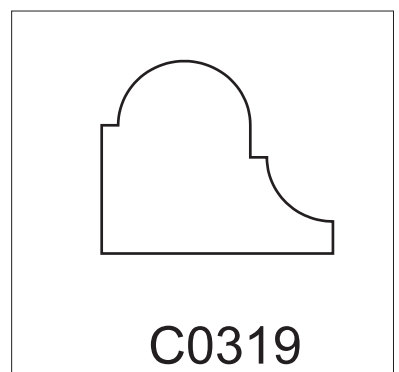
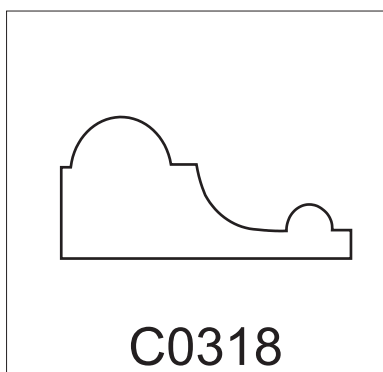
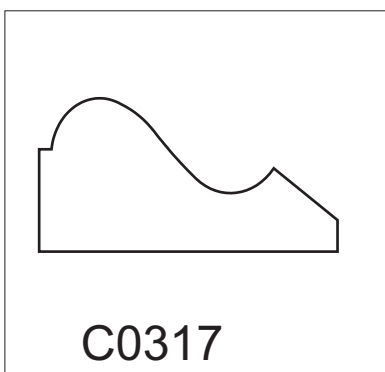
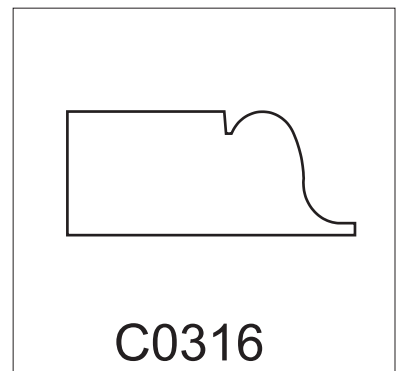
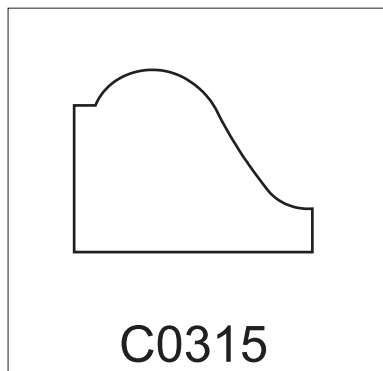
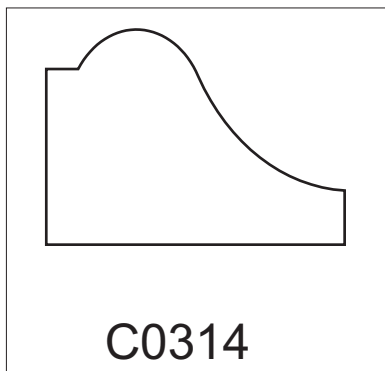
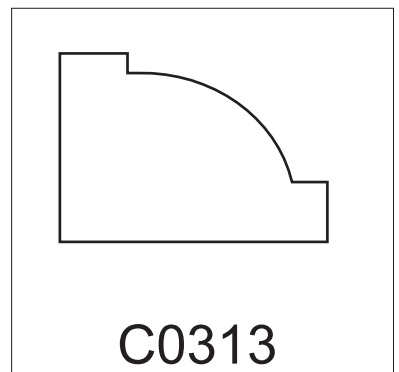
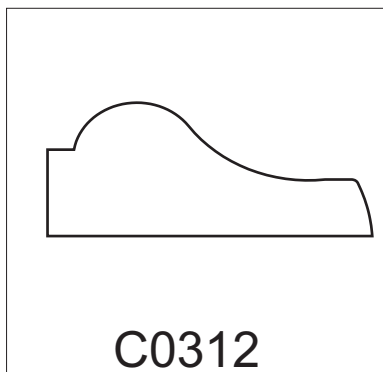
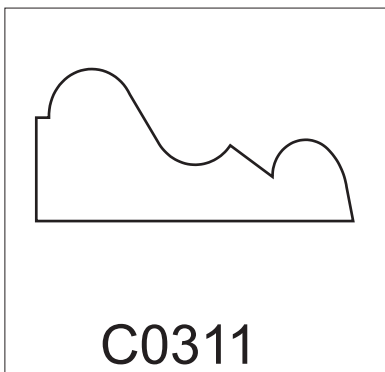
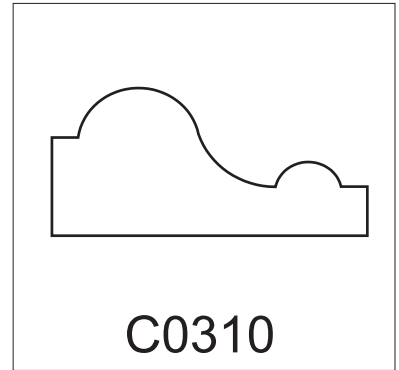
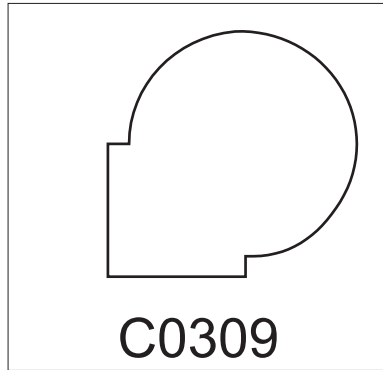
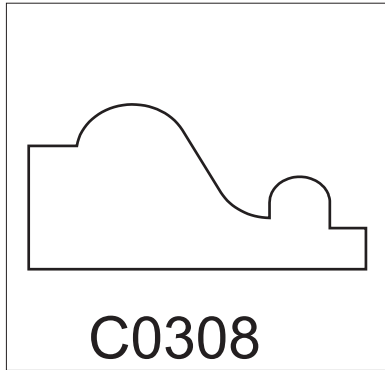

BASE CAPS 3/8

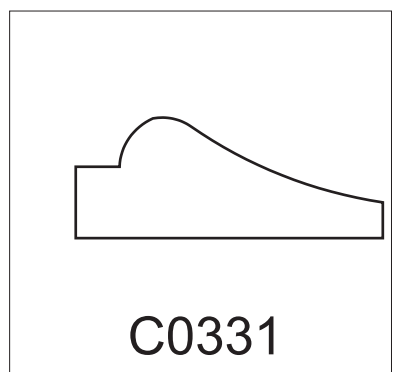
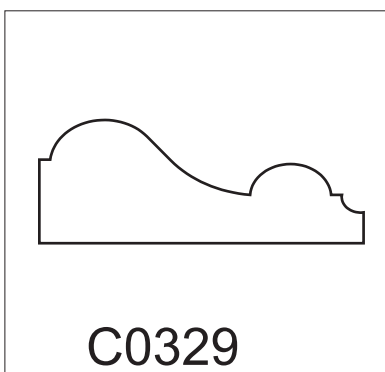
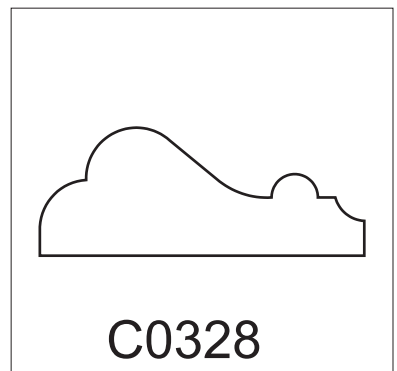
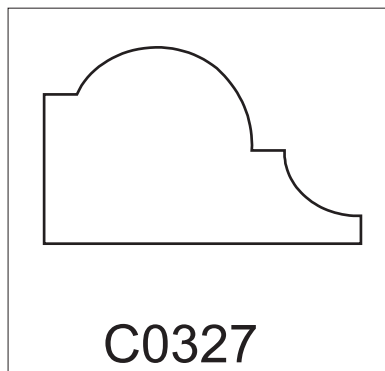
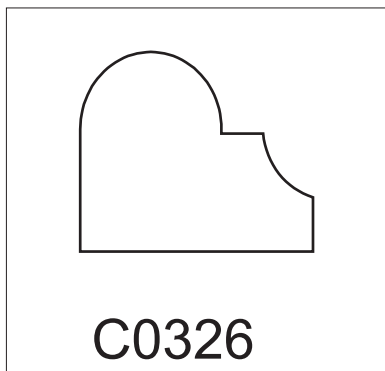
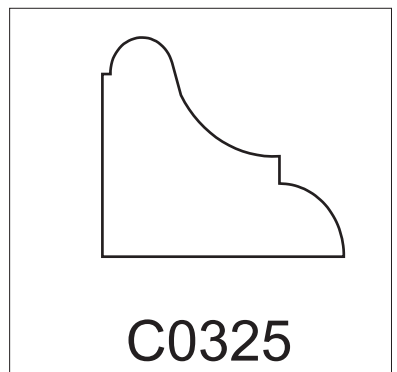
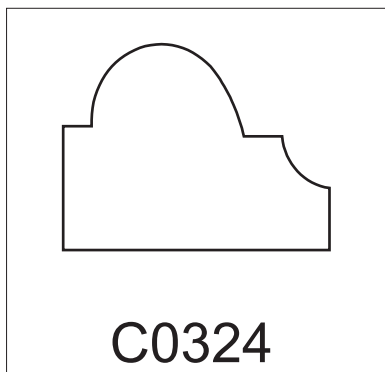
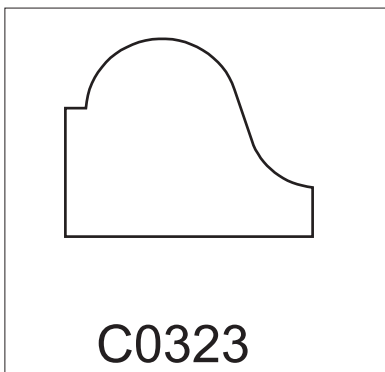
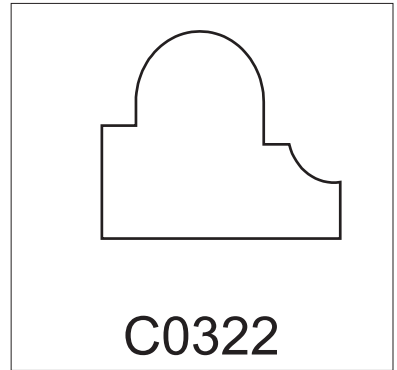
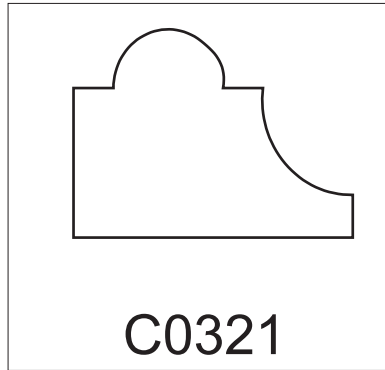
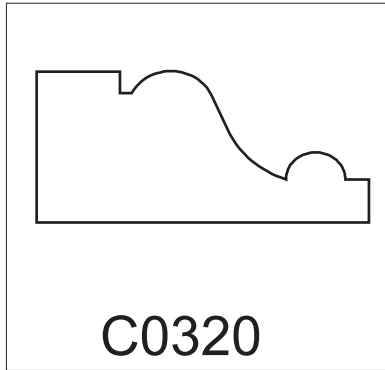

BASE CAPS 4/8

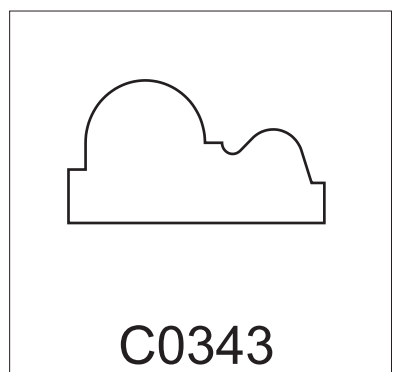
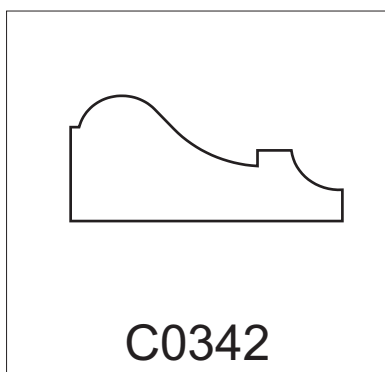
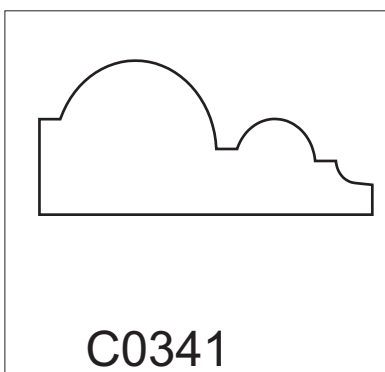
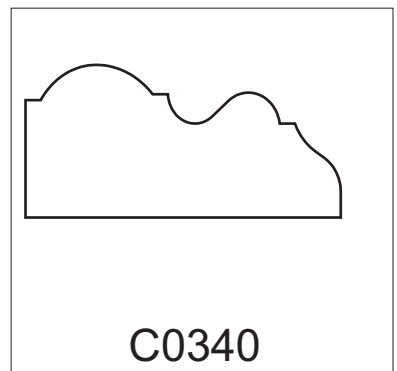
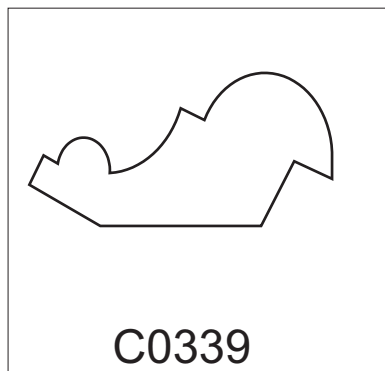
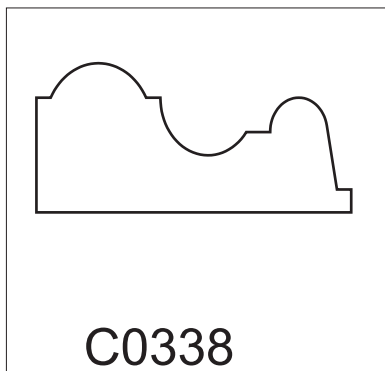
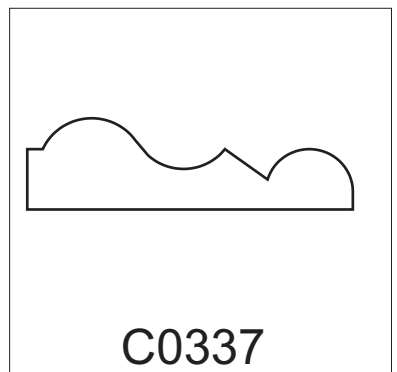
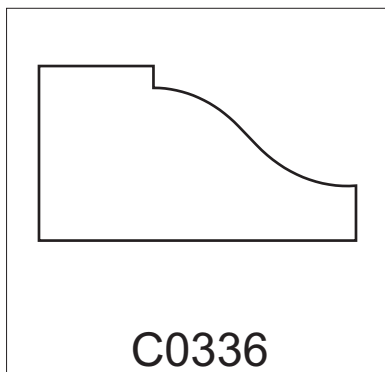
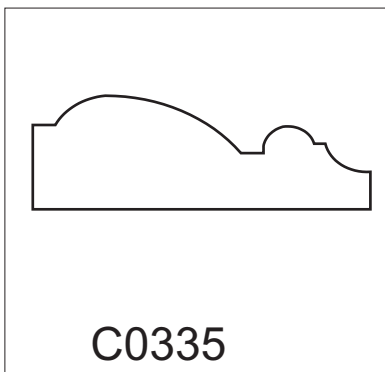
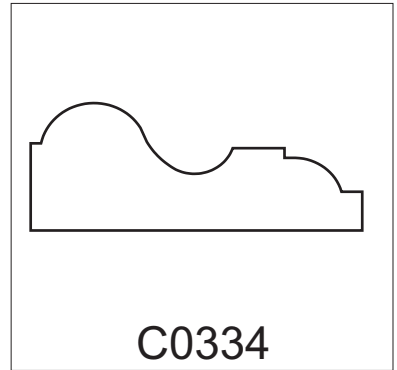
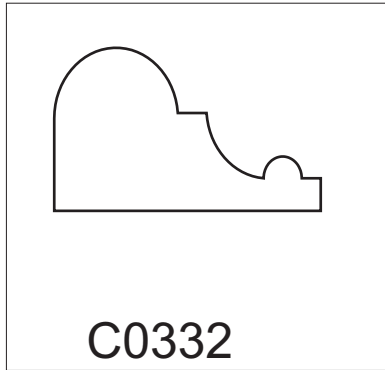

BASE CAPS 5/8



C0344

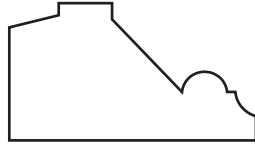

C0345

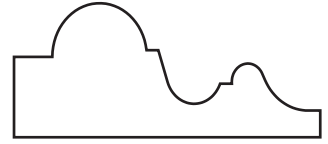

C0346

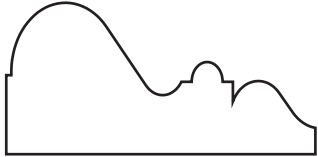

C0347

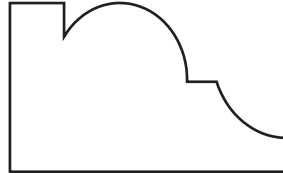

C0348



C0349

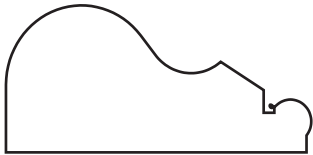

C0350

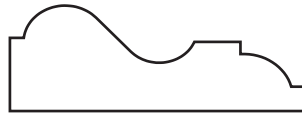

C0351

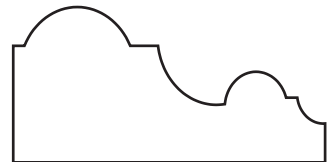

C0352



C0353

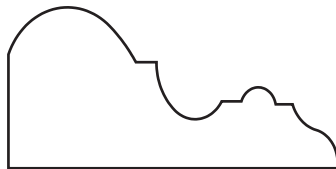

C0354

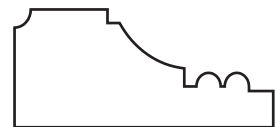

C0355

BASE CAPS 6/8

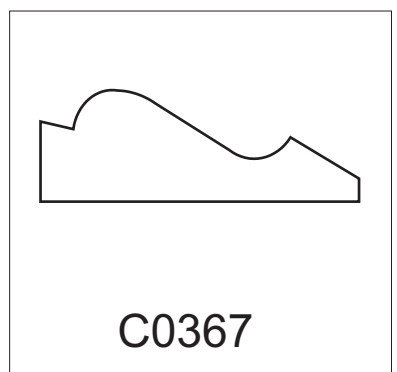
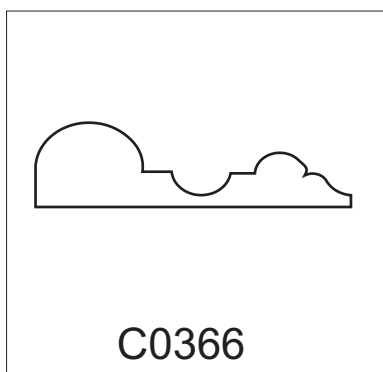
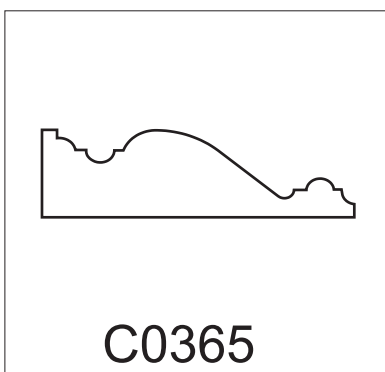
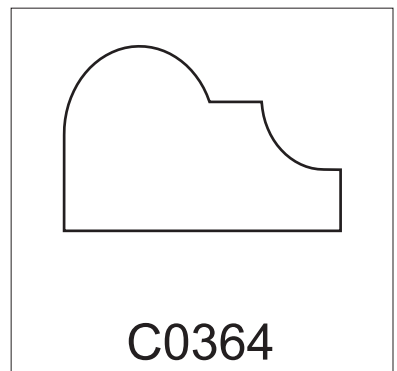
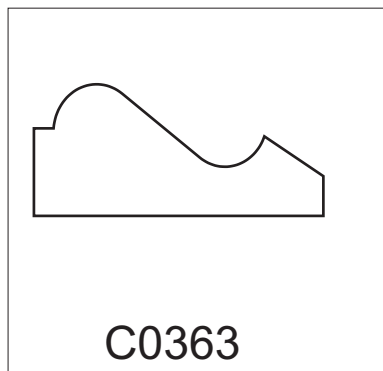
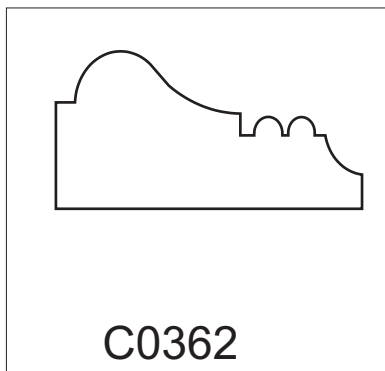
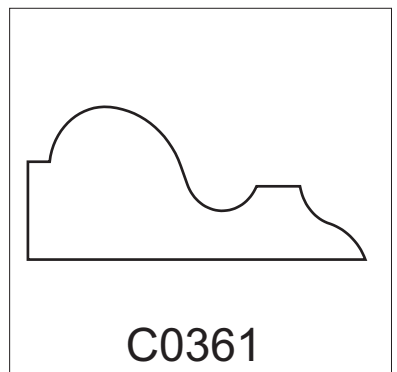
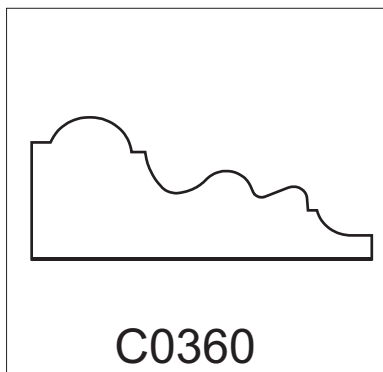
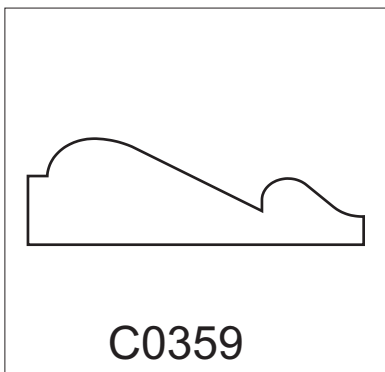
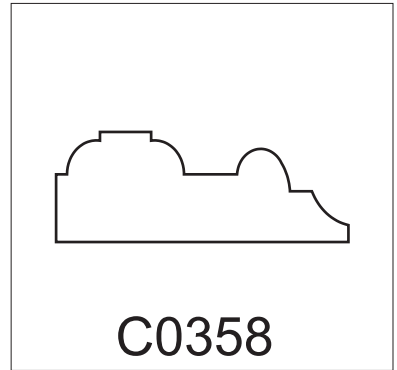
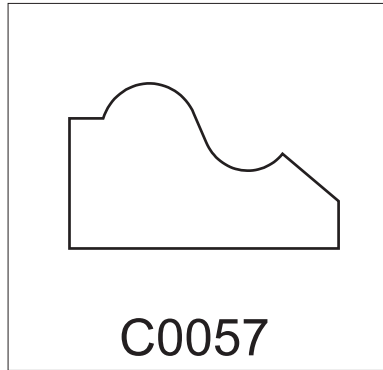
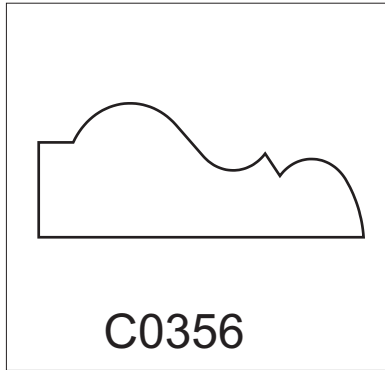

BASE CAPS 7/8

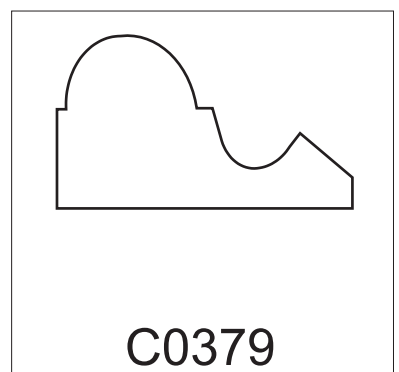
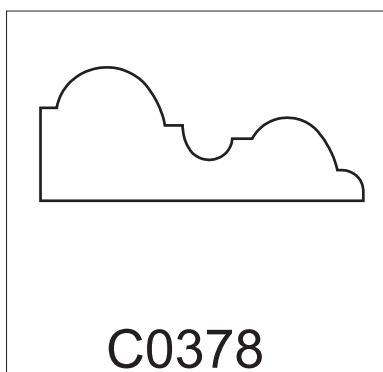
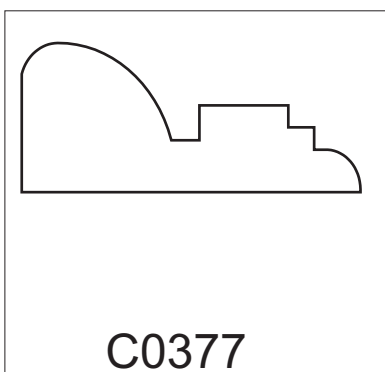
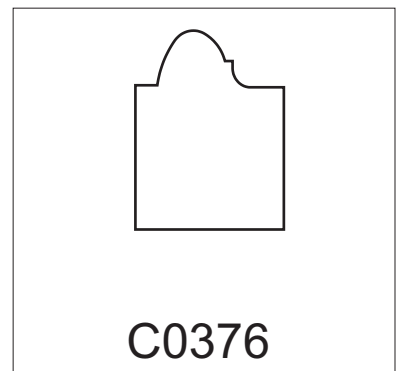
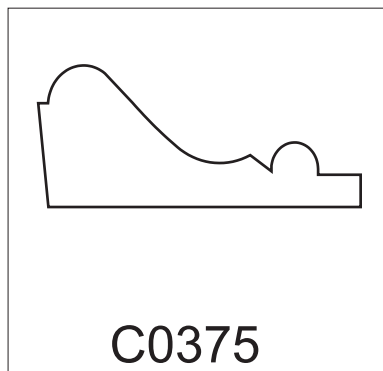
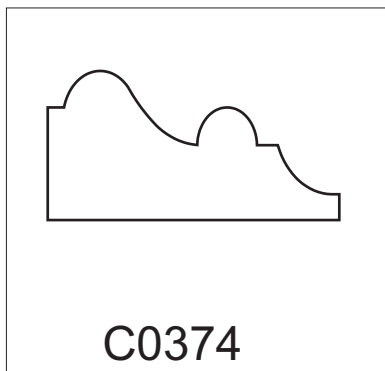
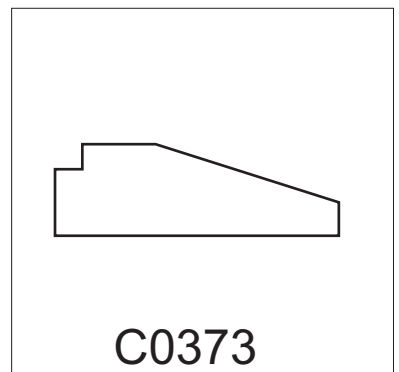
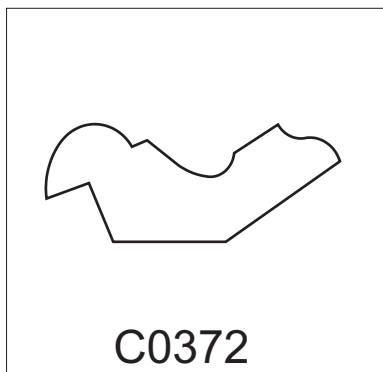
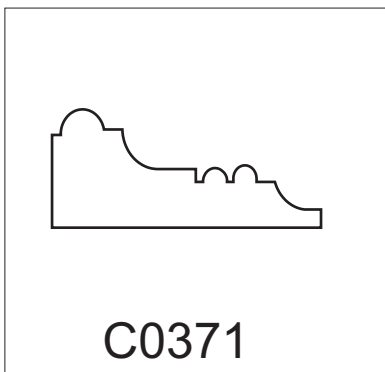
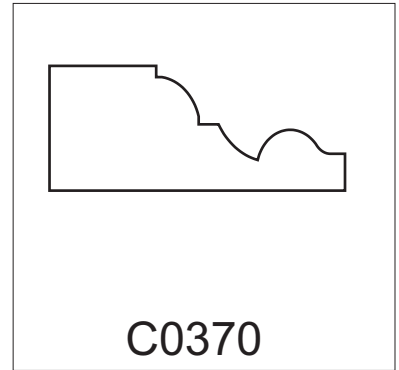
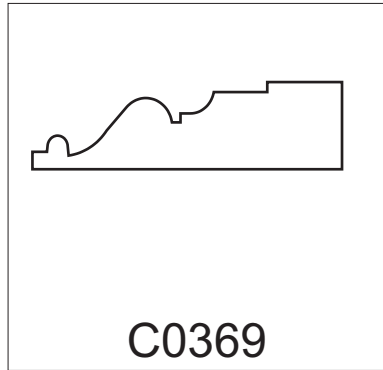
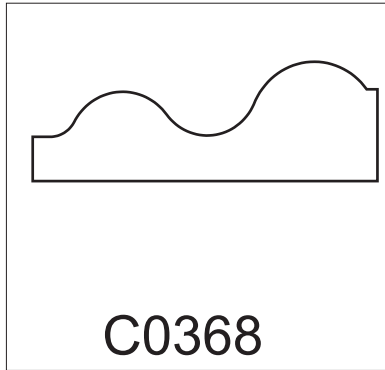

BASE CAPS 8/8

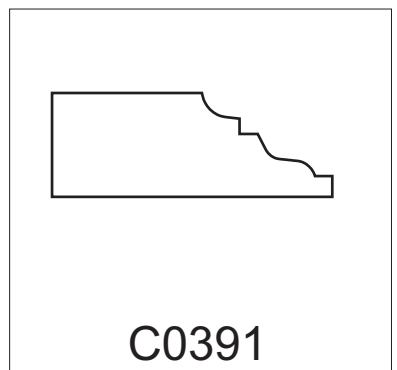
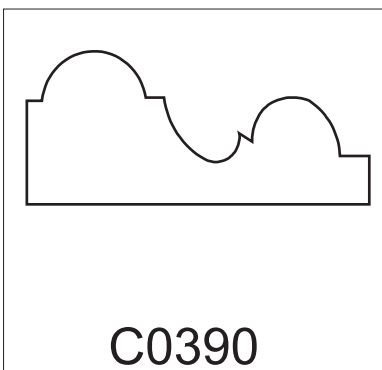
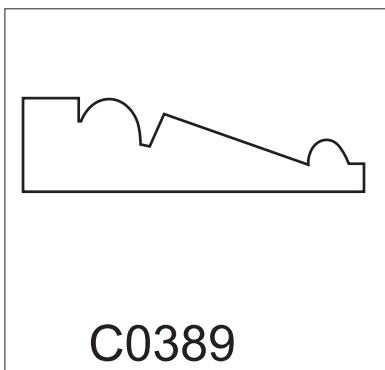
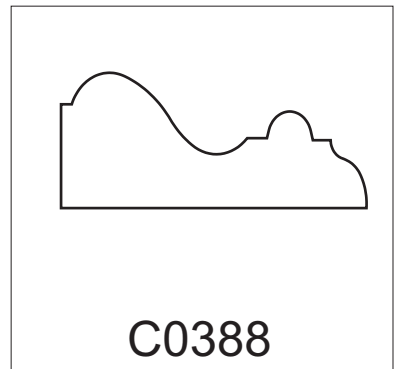
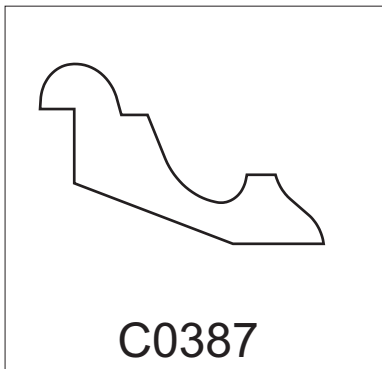
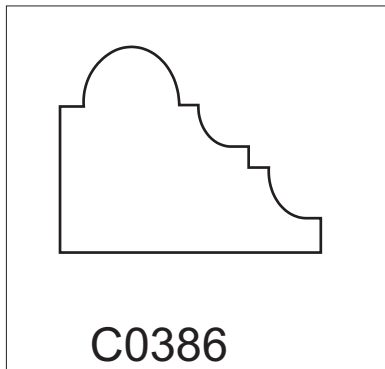
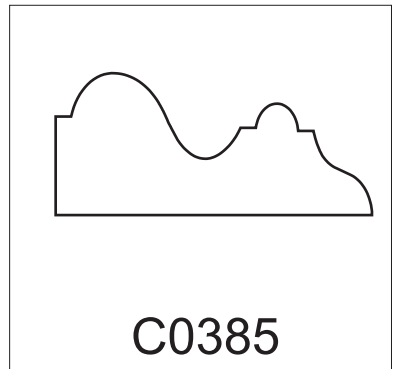
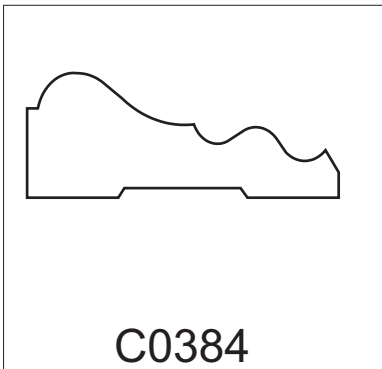
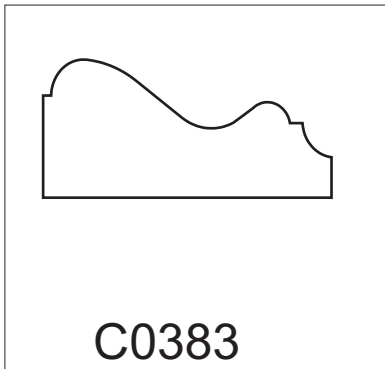
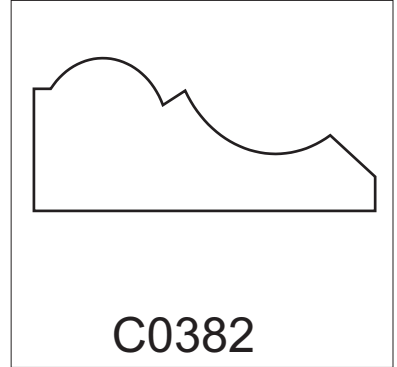
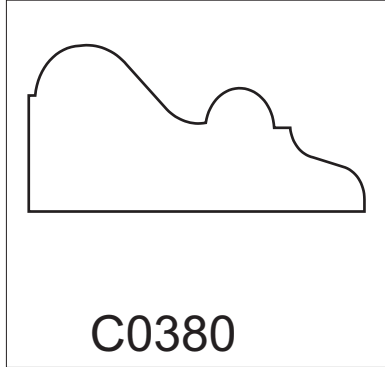

BASE SHOES 1/6

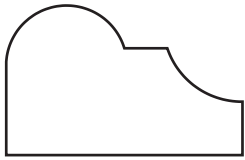

C0392

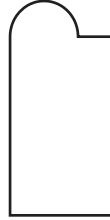

C0393

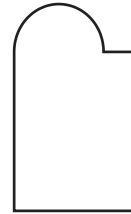

C0394

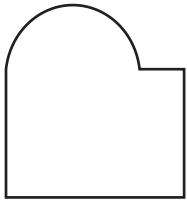

C0395

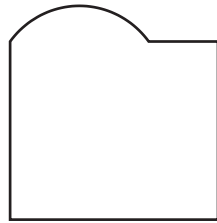

C0396

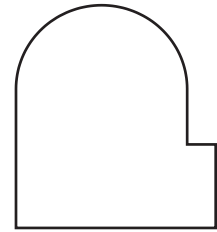

C0397

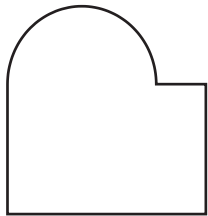

C0398

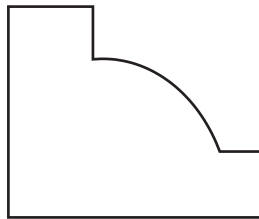

C0399

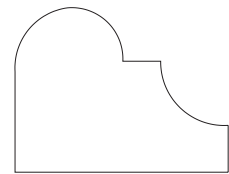

C0400

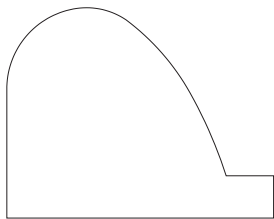

C0401

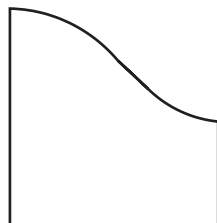

C0402

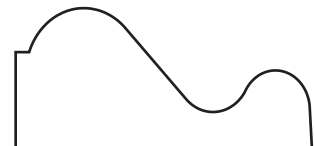

C0403

BASE SHOES 2/6



C0404

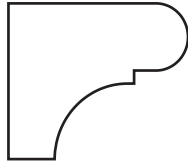

C0405

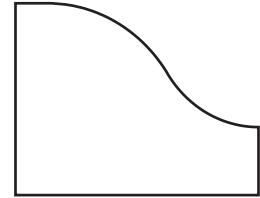

C0406

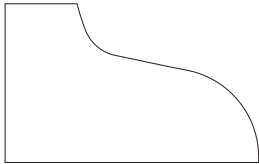

C0407

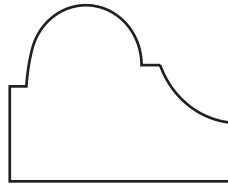

C0408

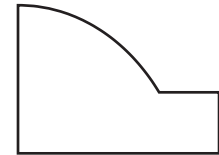

C0409

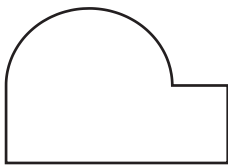

C0410

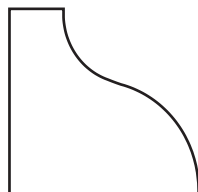

C0411

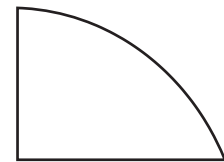

C0412

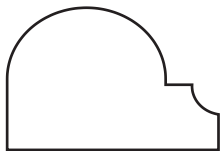

C0413

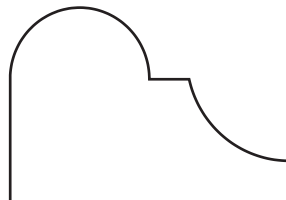

C0414

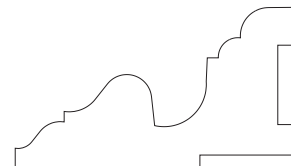

C0415

BASE SHOES 3/6

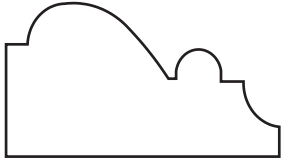

C0416

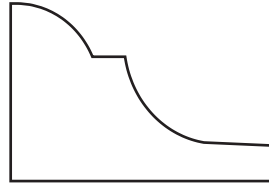

C0417

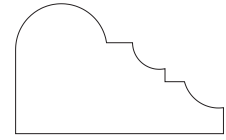

C0418



C0419

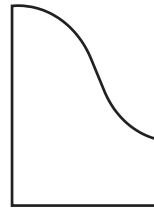

C0420

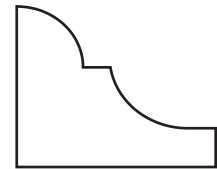

C0421

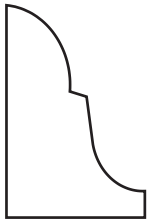

C0422

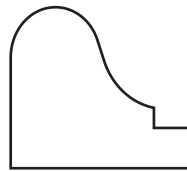

C0423

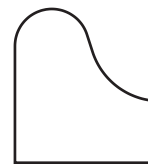

C0424

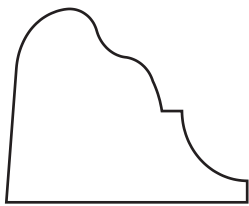

C0425

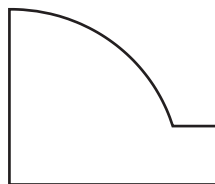

C0426

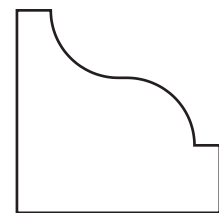

C0427

BASE SHOES 4/6

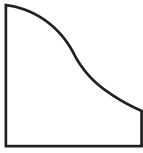

C0428



C0429

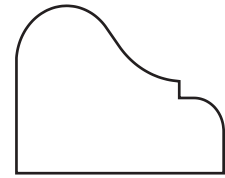

C0430

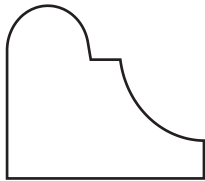

C0431

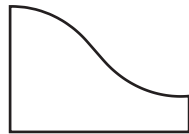

C0432



C0433

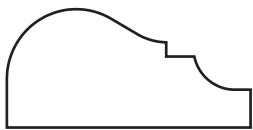

C0434



C0435

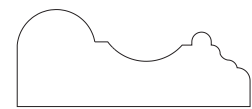

C0436

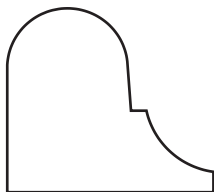

C0437

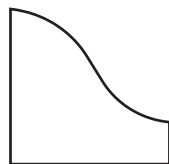

C0438

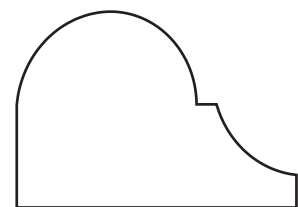

C0439

BASE SHOES 5/6

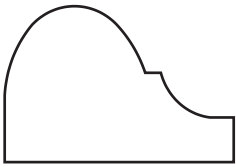

C0440

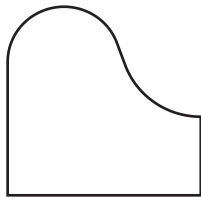

C0441

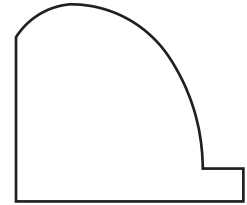

C0442

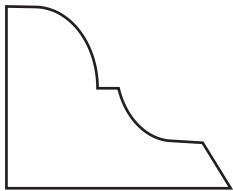

C0443

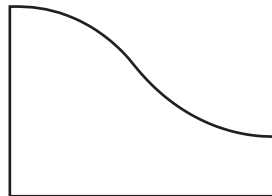

C0444

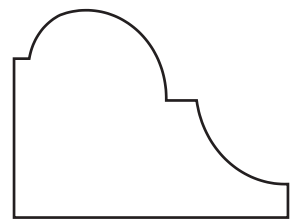

C0445

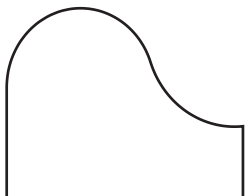

C0446

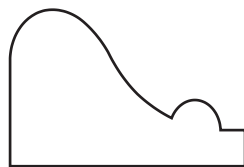

C0447

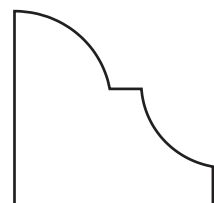

C0448

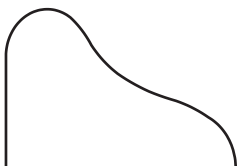

C0449

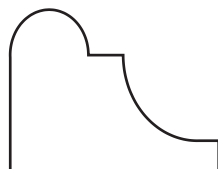

C0450

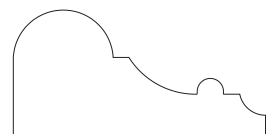

C0451

BASE SHOES 6/6

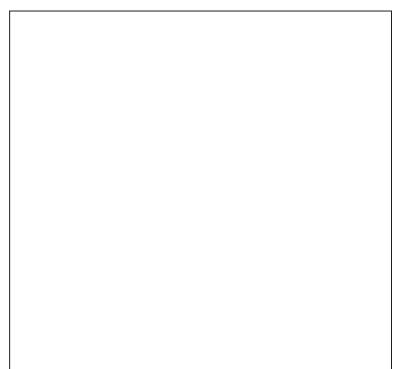
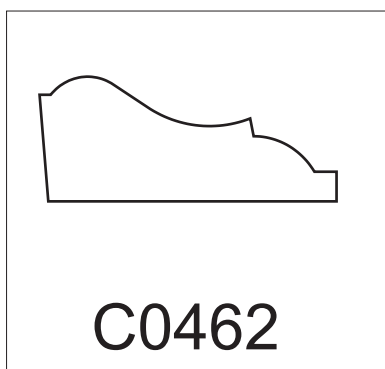
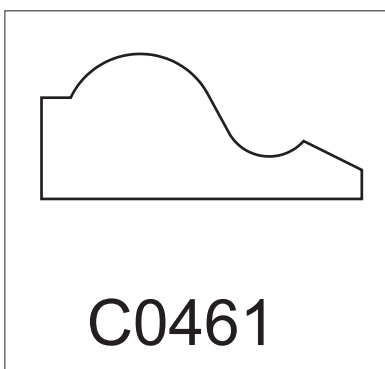
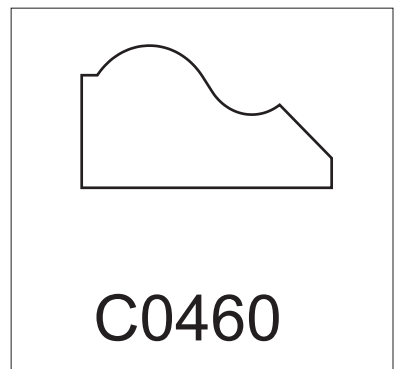
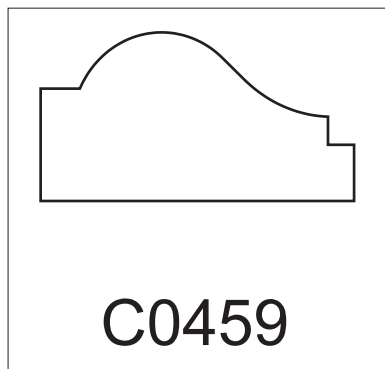
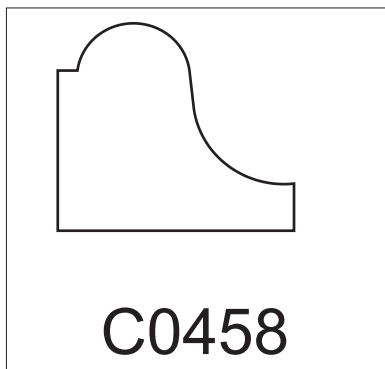
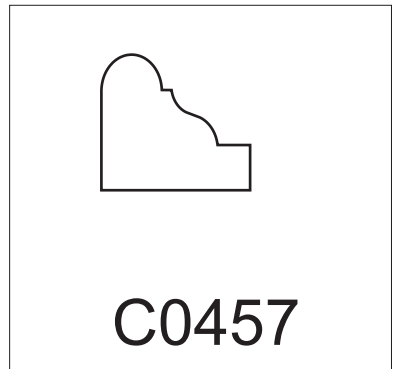
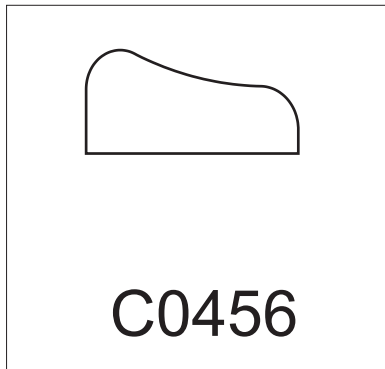
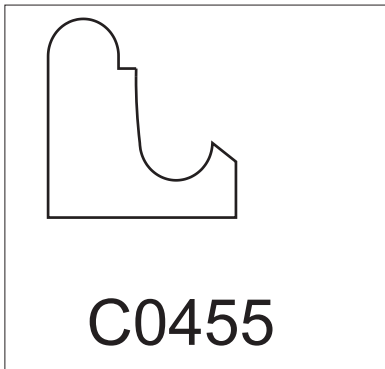
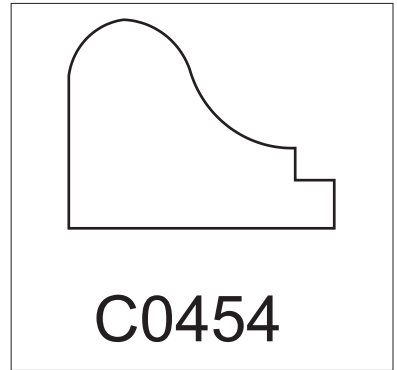
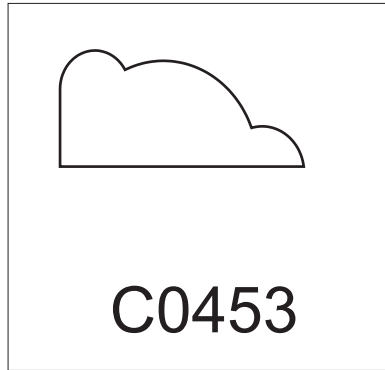
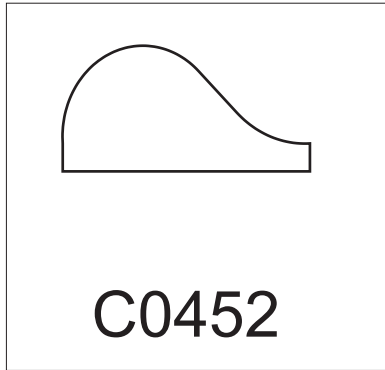

BASES 1/8

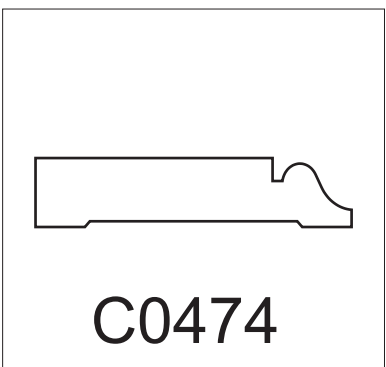
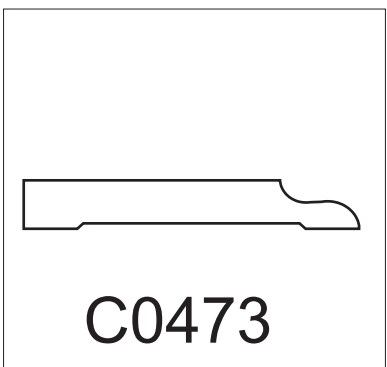
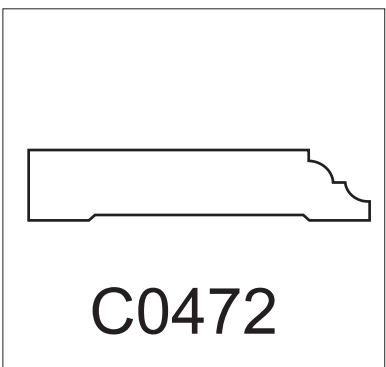
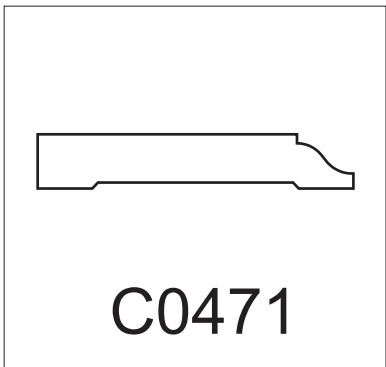
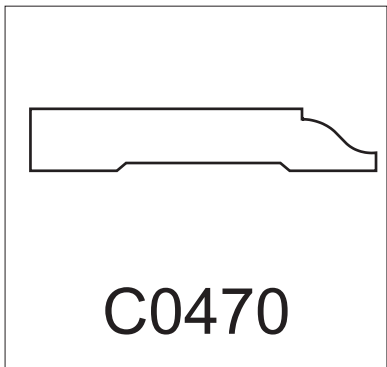
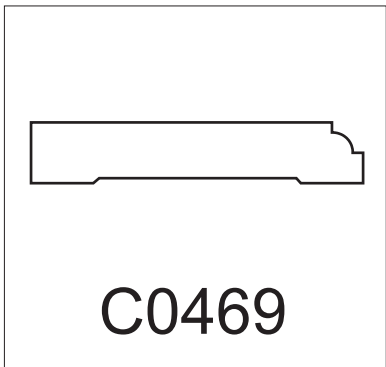
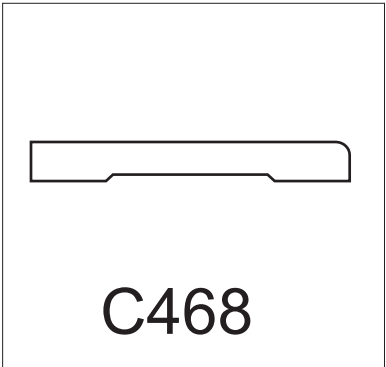
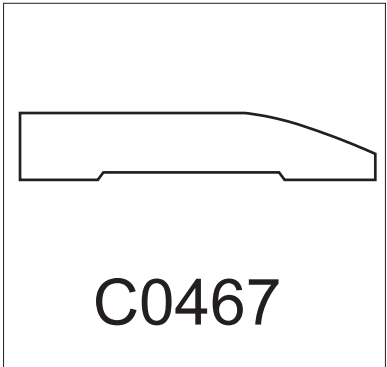
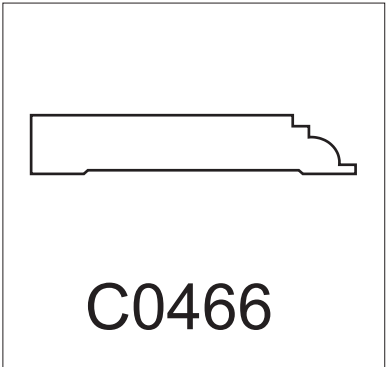
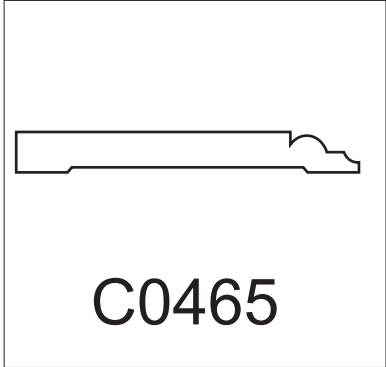
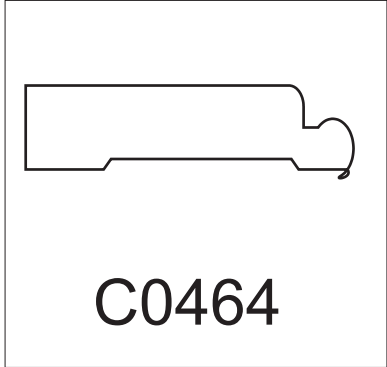
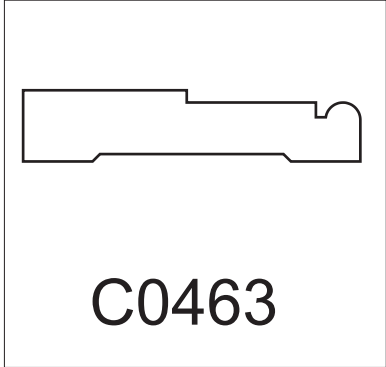

BASES 2/8

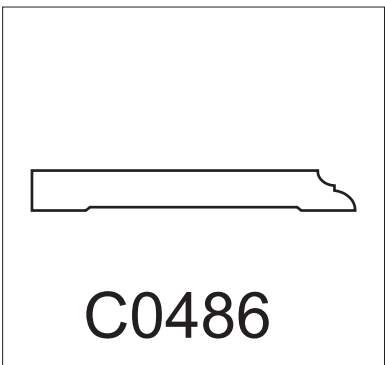
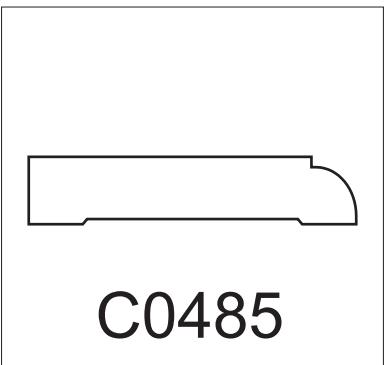
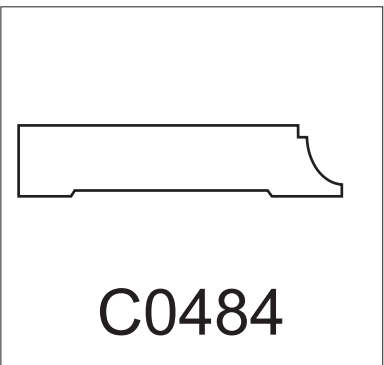
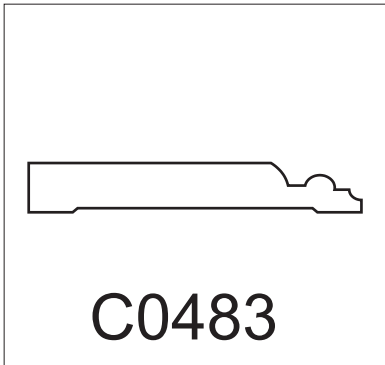
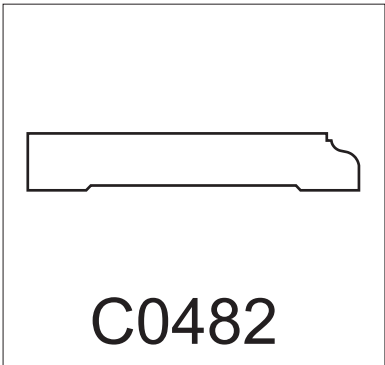
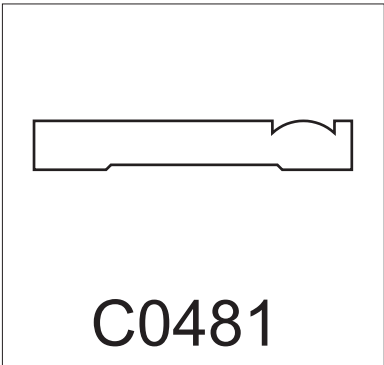
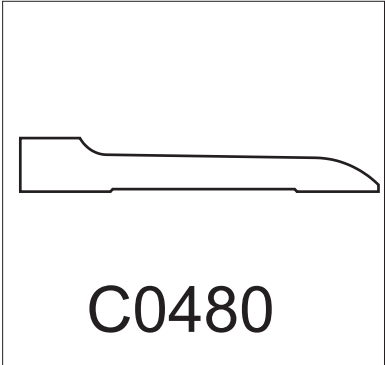
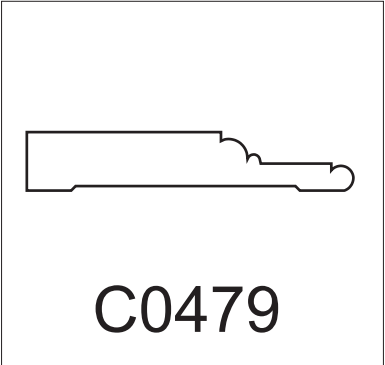
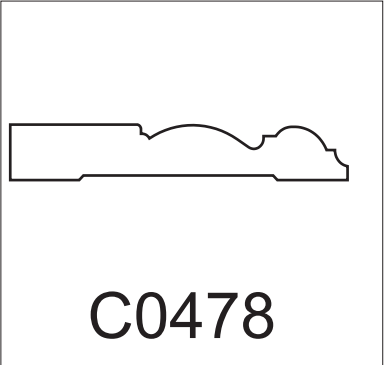
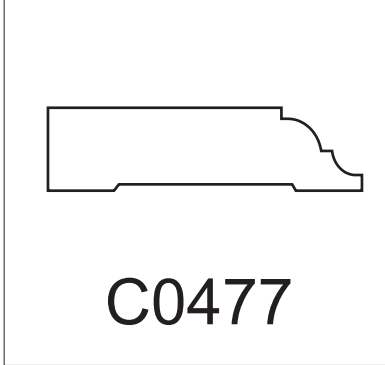
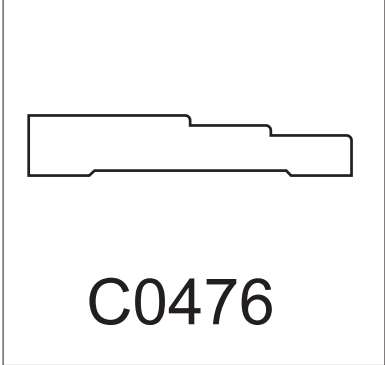
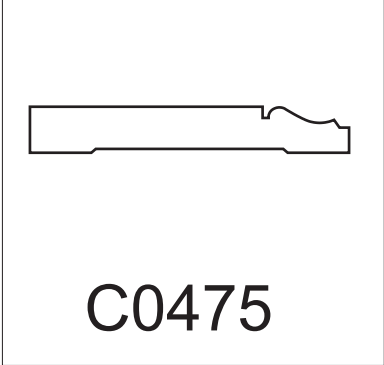

BASES 3/8



C0487

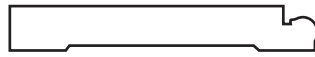

C0488

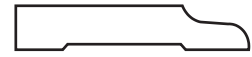

C0489

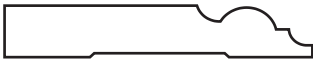

C0490

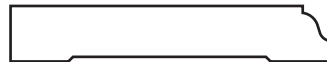

C0491



C0492



C0493

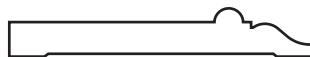

C0494



C0495



C0496



C0497



C0498

BASES 4/8

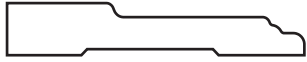

C0499

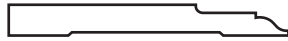

C0500



C0501

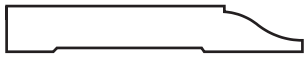

C0502

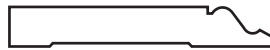

C0503

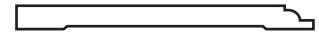

C0504



C0505



C0506

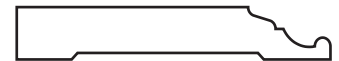

C0507

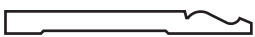

C0508

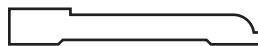

C0509

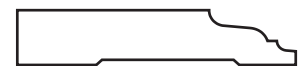

C0510

BASE 5/8

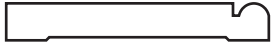

C0511



C0512

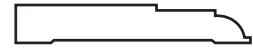

C0513

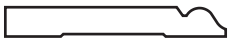

C0514

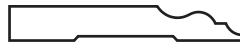

C0515

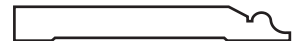

C0516



C0517



C0518

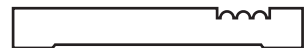

C0519

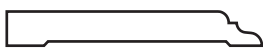

C0520



C0521



C0522

BASES 6/8

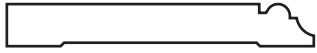

C0523

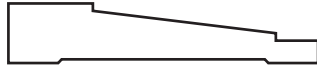

C0524

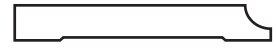

C0525

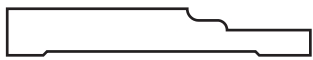

C0526



C0527



C0528

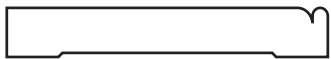

C0529

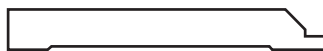

C0530

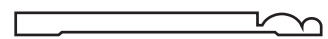

C0531

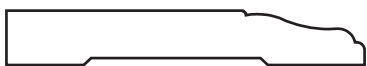

C0532



C0533

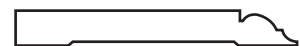

C0534

BASES 7/8

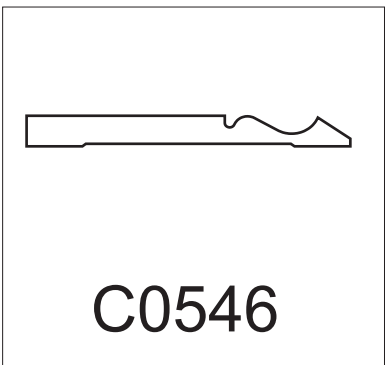
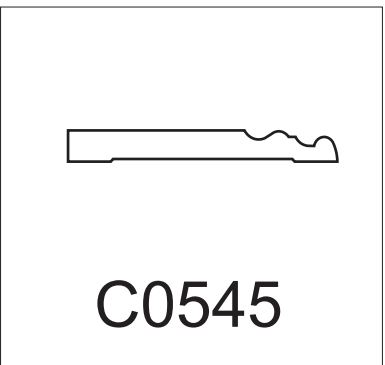
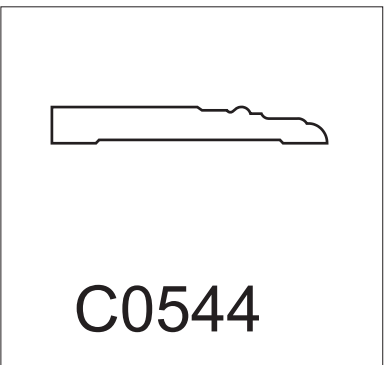
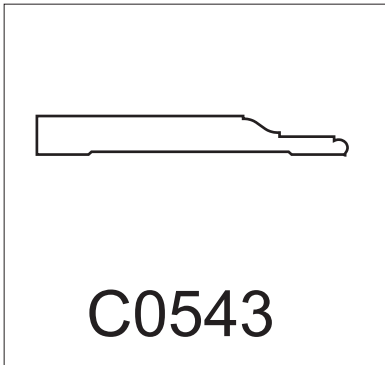
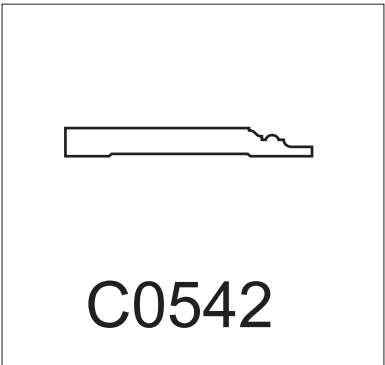
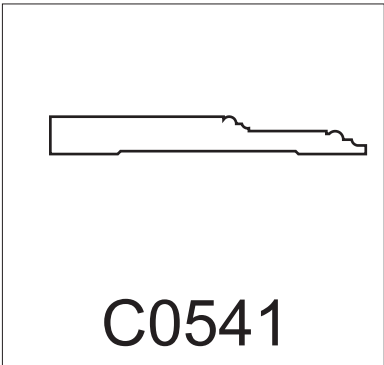
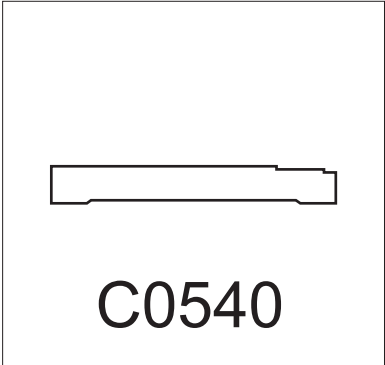
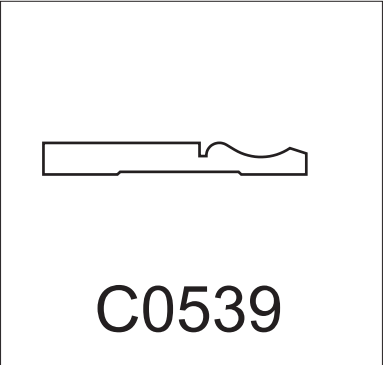
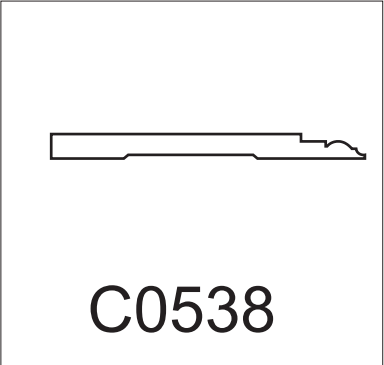
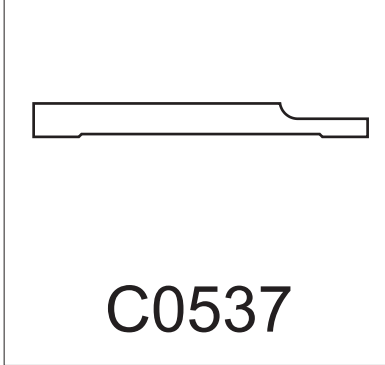
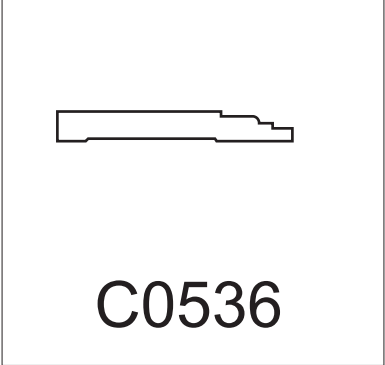
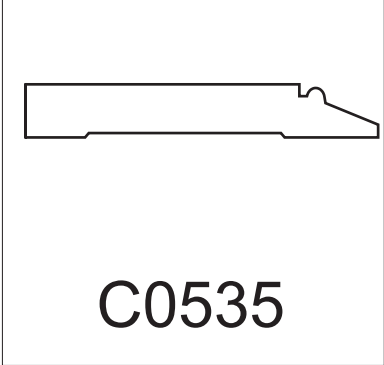

BASES 8/8

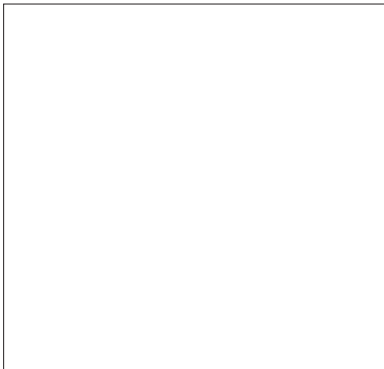
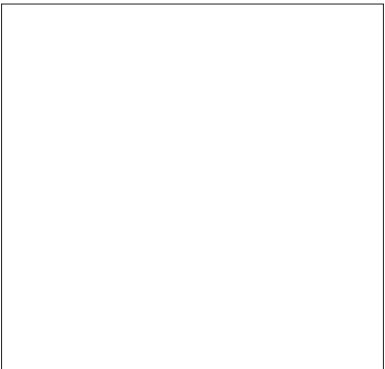
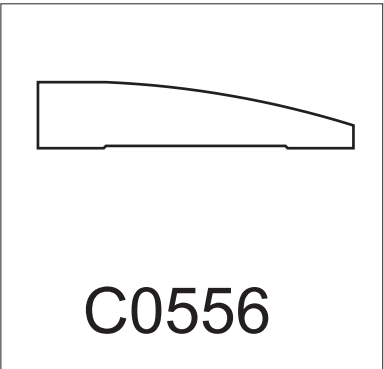
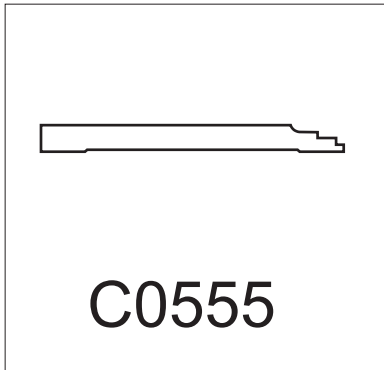
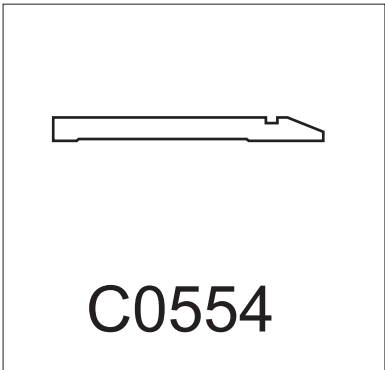
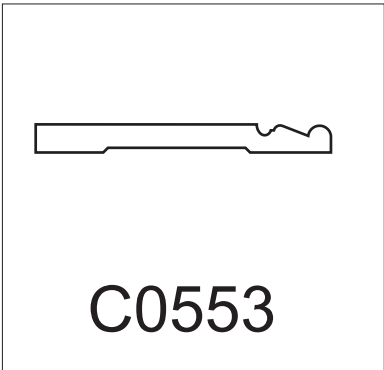
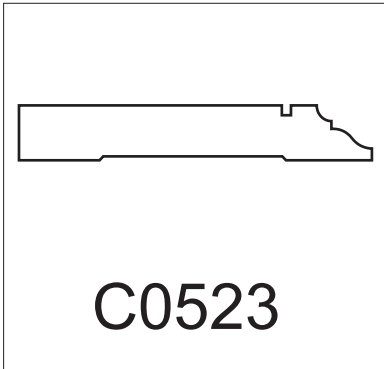
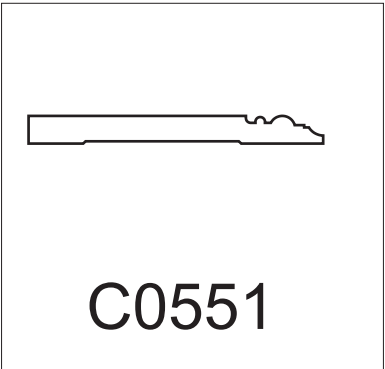
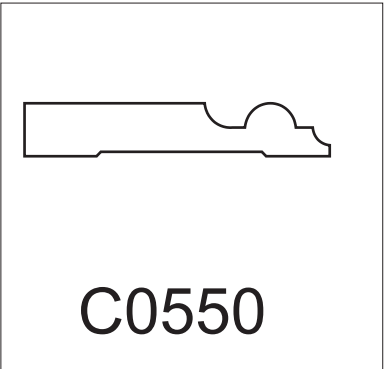
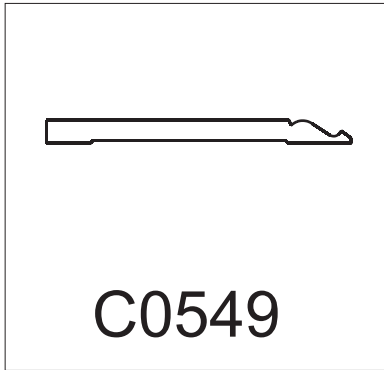
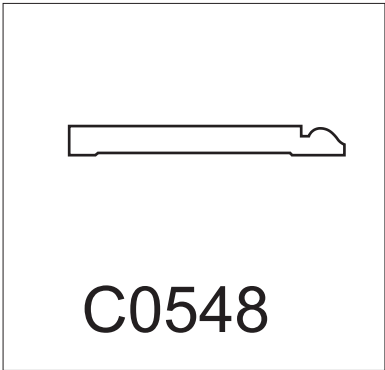
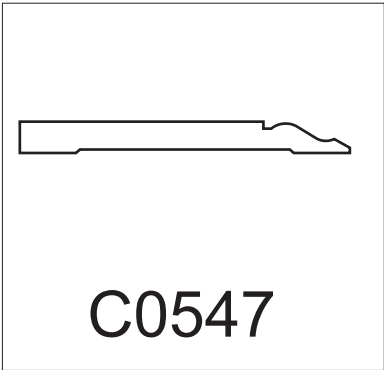

BEDS 1/3

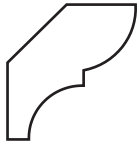

C0557



C0558

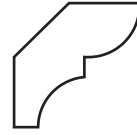

C0559



C0560

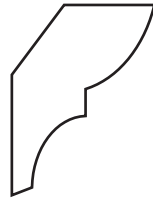

C0561



C0562

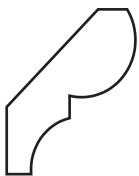

C0563



C0564

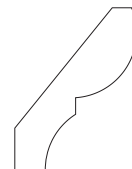

C0565



C0566

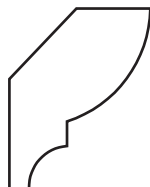

C0567

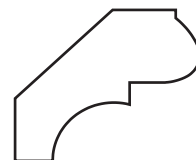

C0568

BEDS 2/3

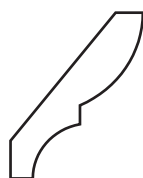

C0569

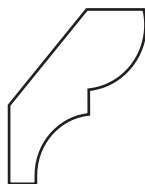

C0570

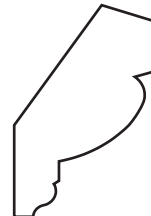

C0571



C0572

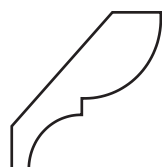

C0573



C0574

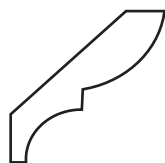

C0575

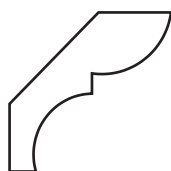

C0576

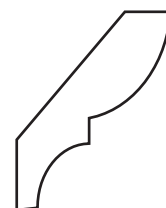

C0577

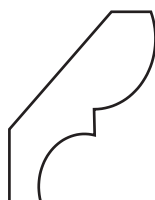

C0578

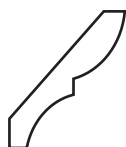

C0579

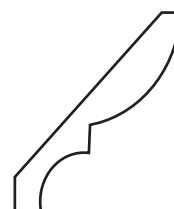

C0580

BEDS 3/3

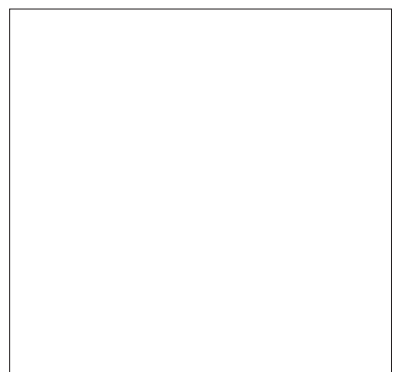
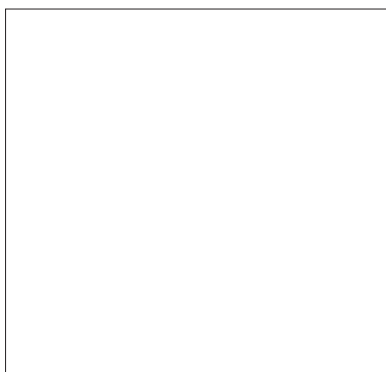
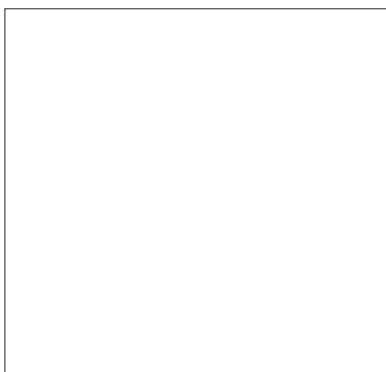
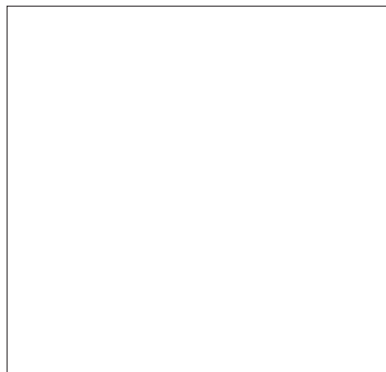
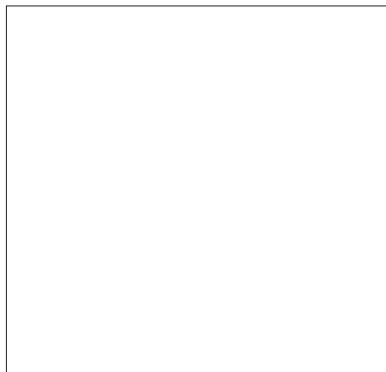
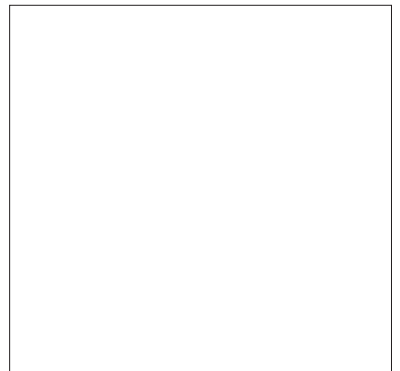
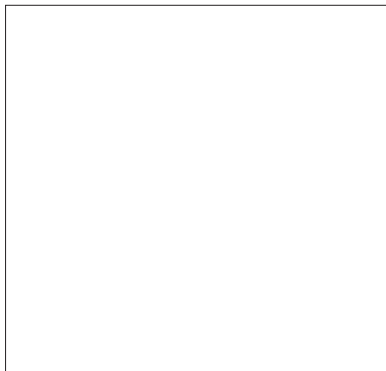
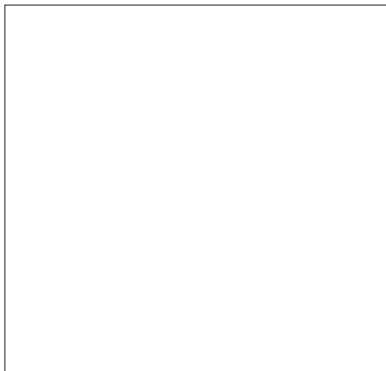
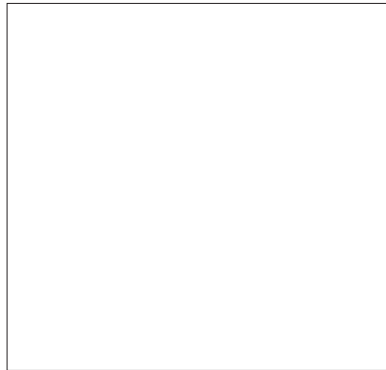
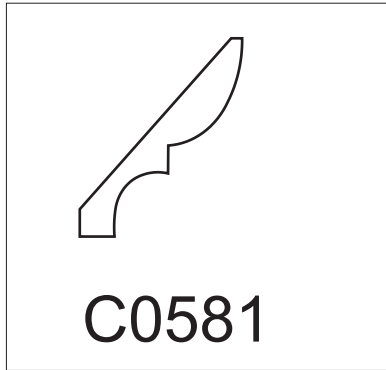

BRICK MOULDS 1/1

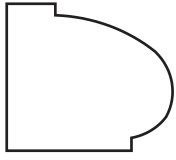

C0582

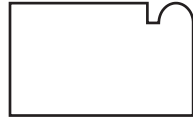

C0583

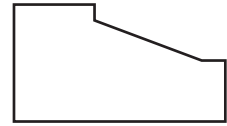

C0584



C0585

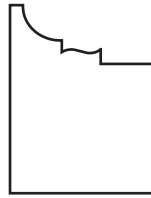

C0586

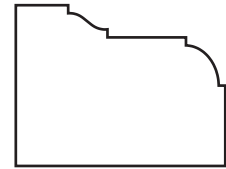

C0587

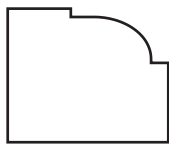

C0588

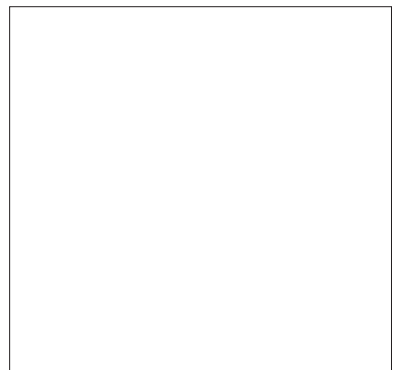
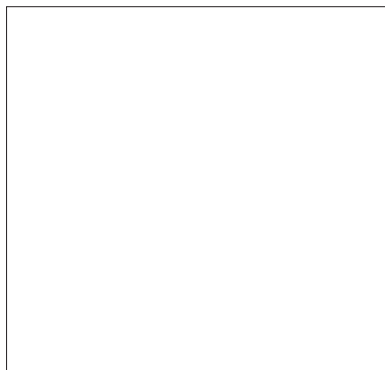
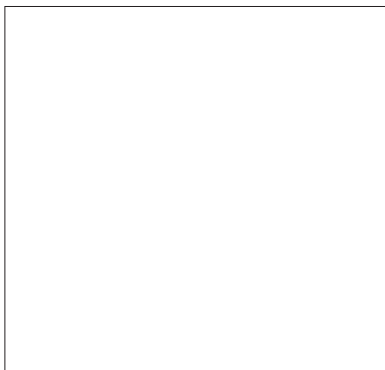

CASINGS 1/8

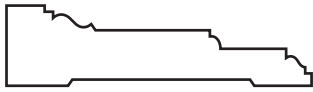

C0589



C0590

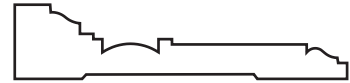

C0591



C0592



C0593



C0594



C0595



C0596

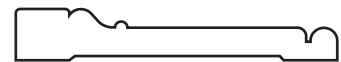

C0597



C0598

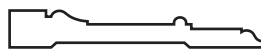

C0599



C0600

CASINGS 2/8



C0601



C0602

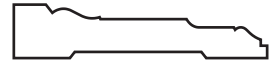

C0603



C0604

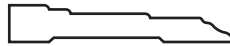

C0605

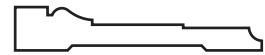

C0606

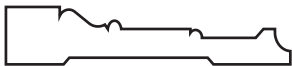

C0607

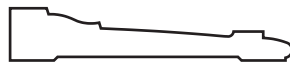

C0608



C0609



C0610



C0611



C0612

CASINGS 3/8



C0613



C0614

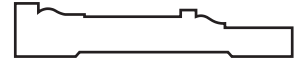

C0615



C0616



C0617



C0618



C0619

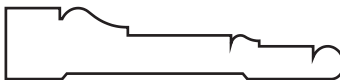

C0620



C0621



C0622



C0623



C0624

CASINGS 4/8



C0625



C0626

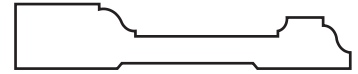

C0627

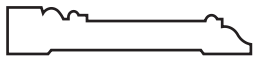

C0628

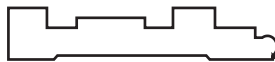

C0629



C0630



C0631



C0632



C0633

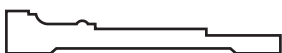

C0634



C0635

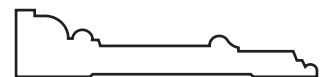

C0636

CASINGS 5/8

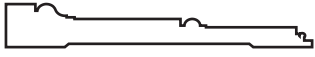

C0637

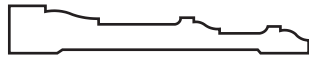

C0638

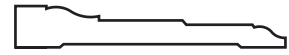

C0639



C0640



C0641



C0642

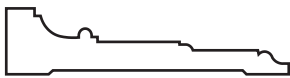

C0643



C0644

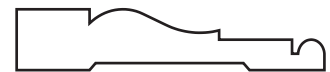

C0645

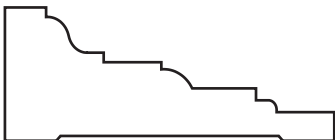

C0646



C0647



C0648

CASINGS 6/8



C0649



C0650

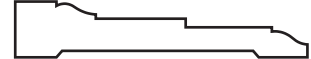

C0651

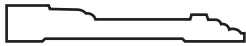

C0652

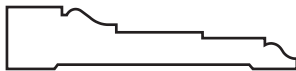

C0653



C0654

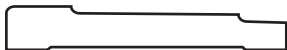

C0655



C0656

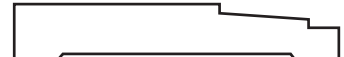

C0657



C0658



C0659



C0660

CAINGS 7/8



C0661



C0662



C0663



C0664



C0665



C0666

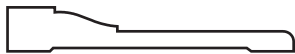

C0667

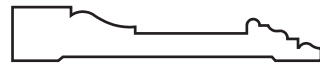

C0668



C0669



C0670



C0671



C0672

CASINGS 8/8



C0673



C0674

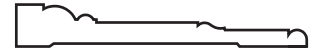

C0675



C0676



C0677

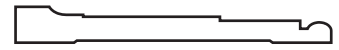

C0678



C0679



C0680

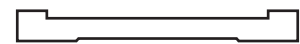

C0681



C0682



C0683

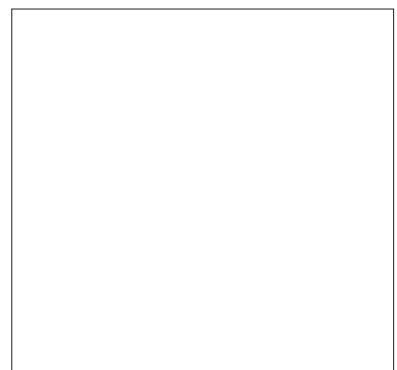

CHAIR RAILS 1/9

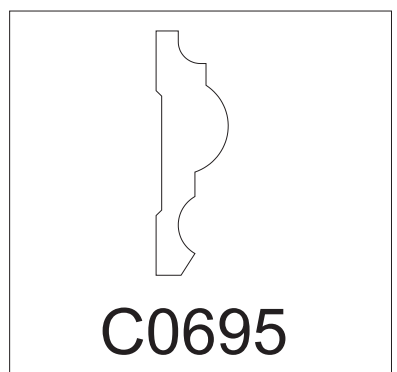
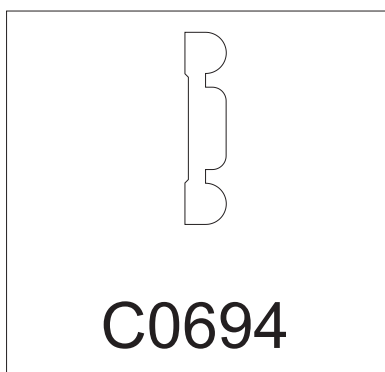
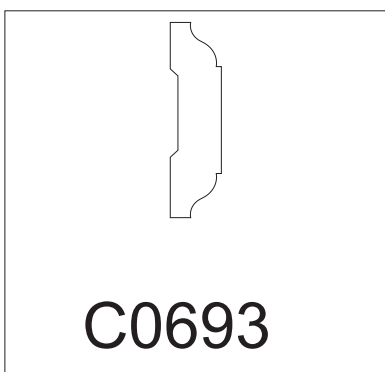
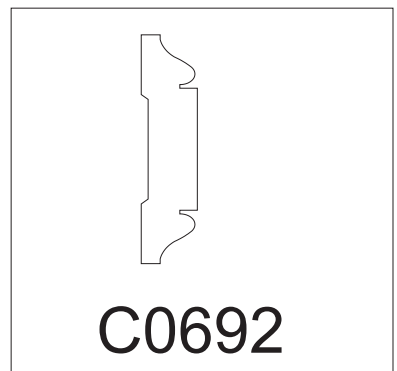
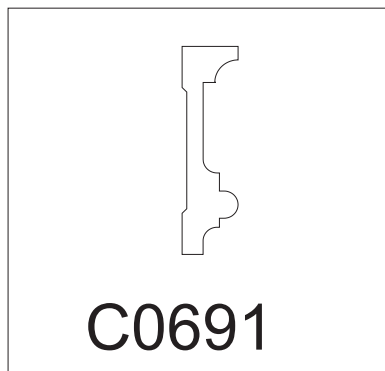
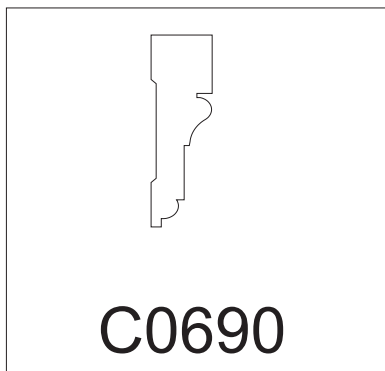
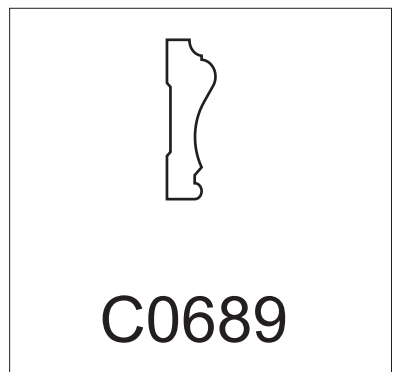
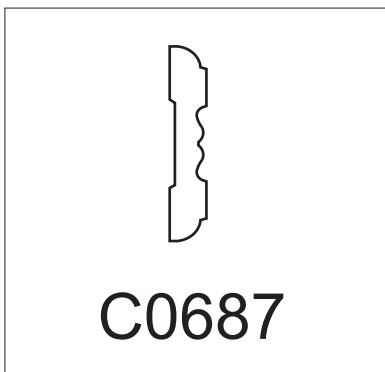
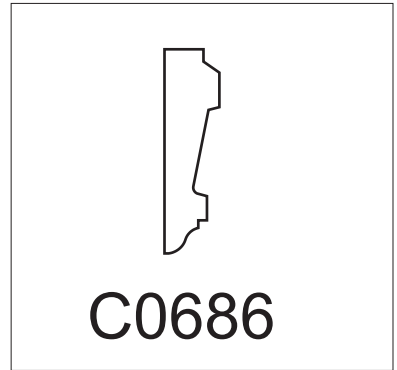
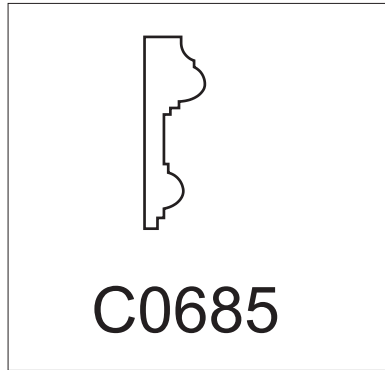

CHAIR RAILS 2/9

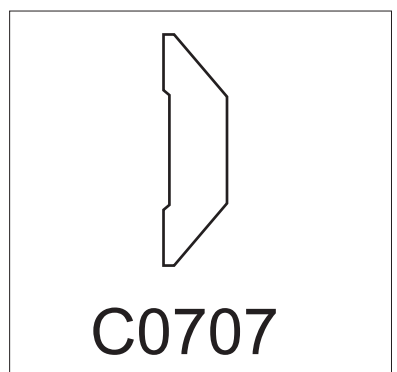
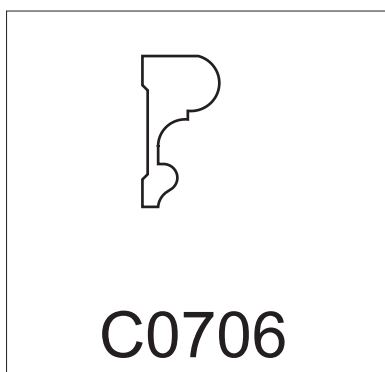
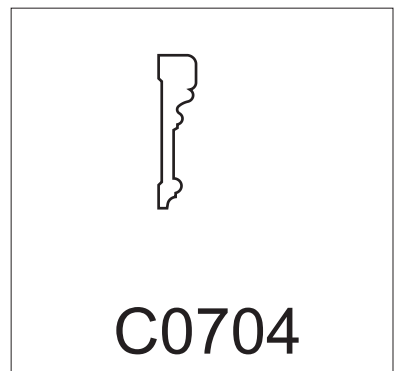
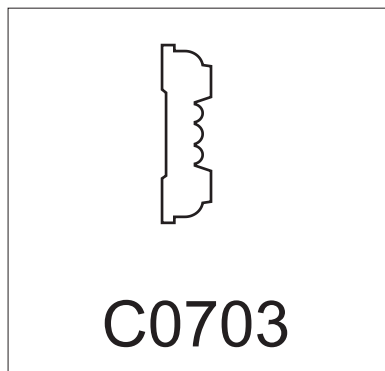
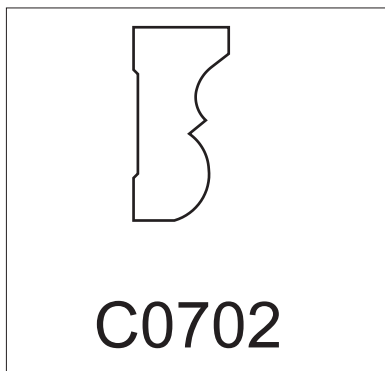
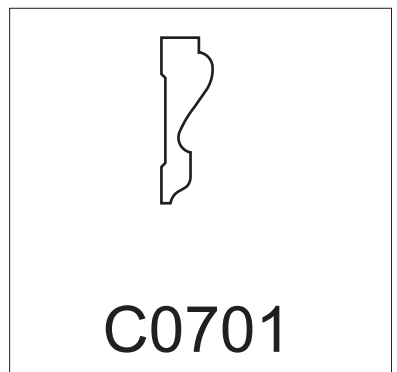
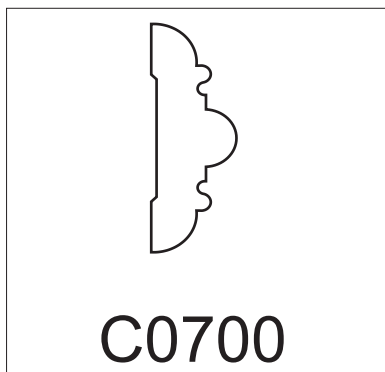
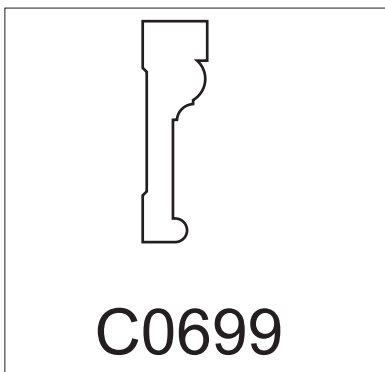
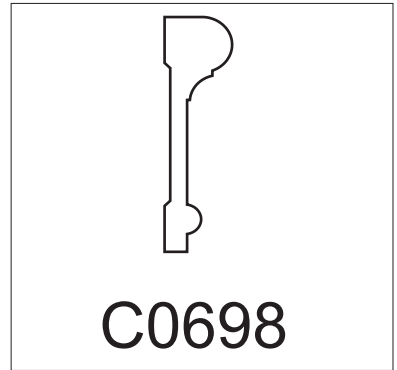
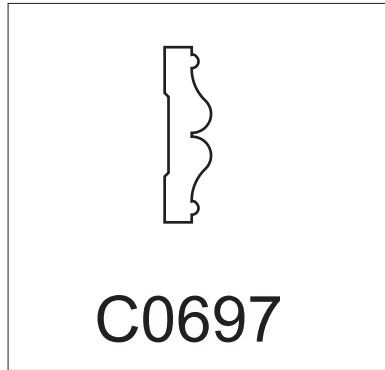
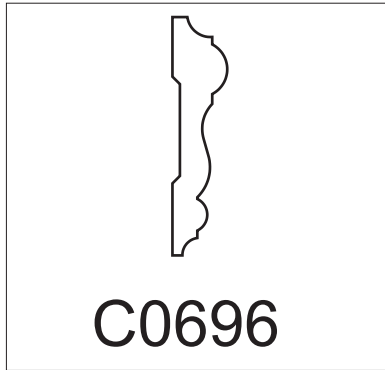

CHAIR RAILS 3/9



C0708



C0709



C0710



C0711



C0712

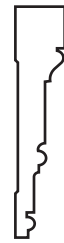

C0713



C0714

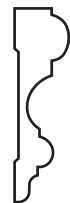

C0715



C0716



C0717



C0718



C0719

CHAIR RAILS 4/9



C0720



C0721



C0722



C0723



C0724



C0725



C0726

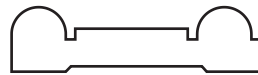

C0727



C0728



C0729



C0730



C0731

CHAIR RAILS 5/9

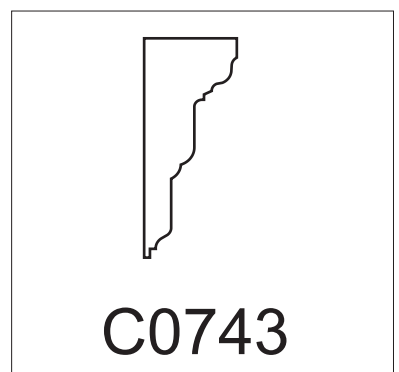
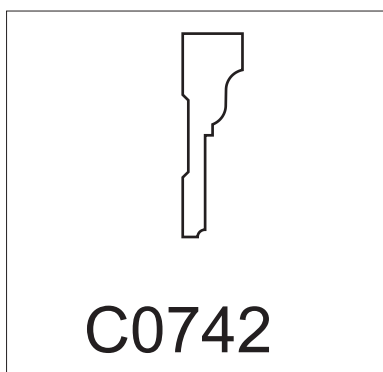
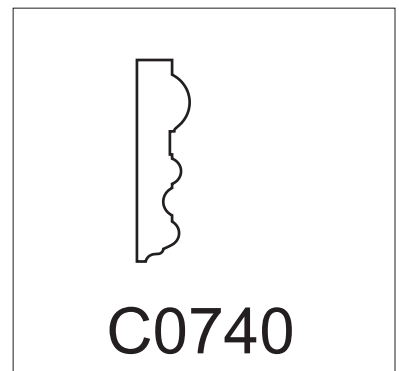
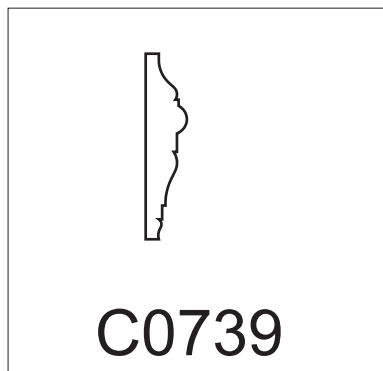
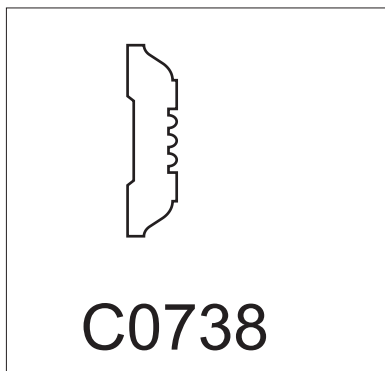
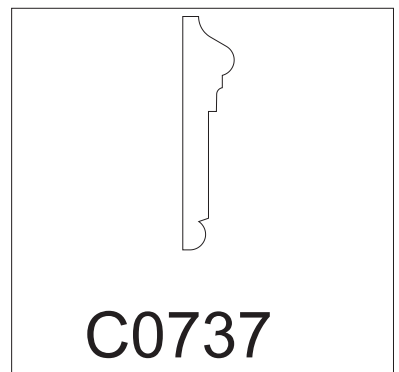
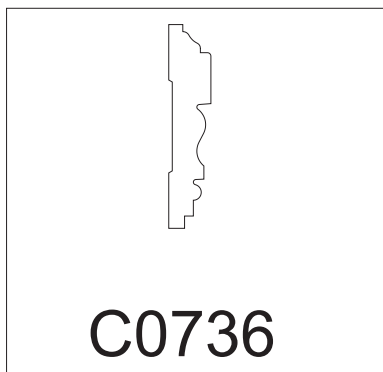
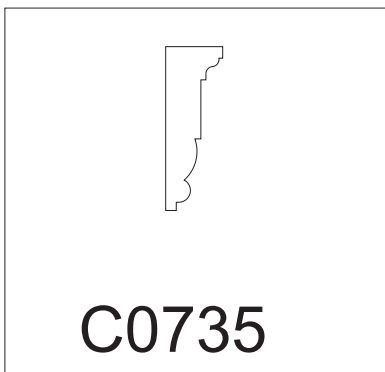
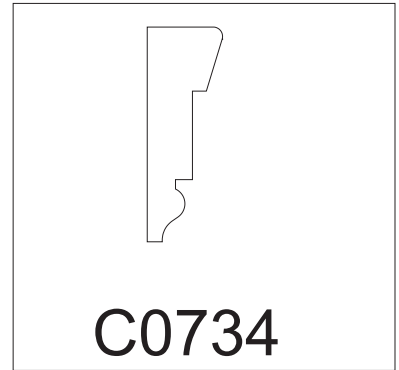
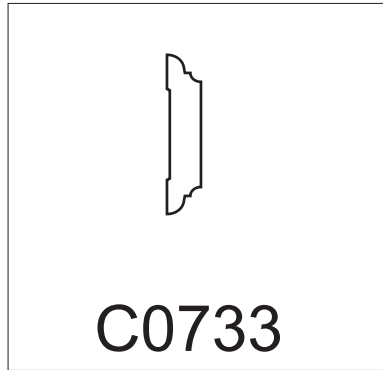
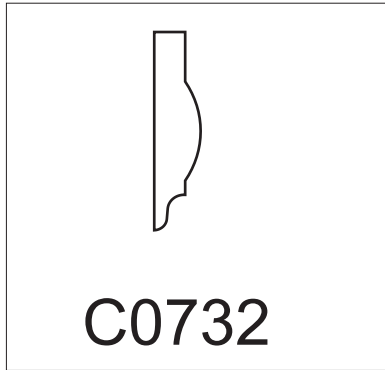

CHAIR RAILS 6/9



C0744



C0745



C0746



C0747



C0748

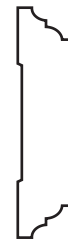

C0749



C0750



C0751



C0752



C0753



C0754



C0755

CHAIR RAILS 7/9

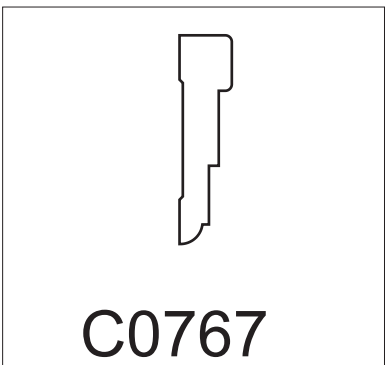
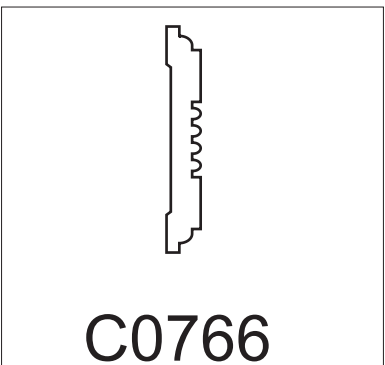
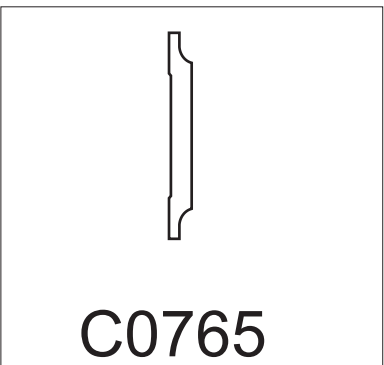
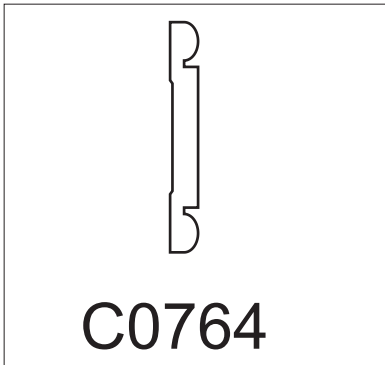
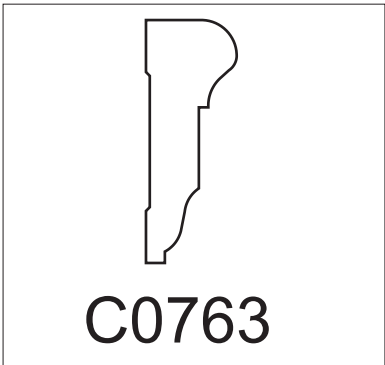
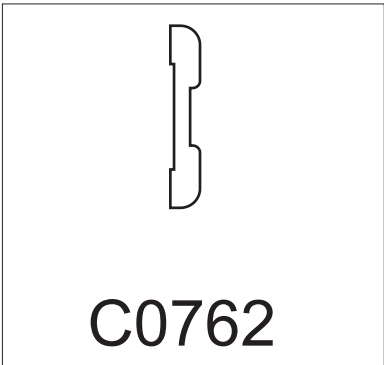
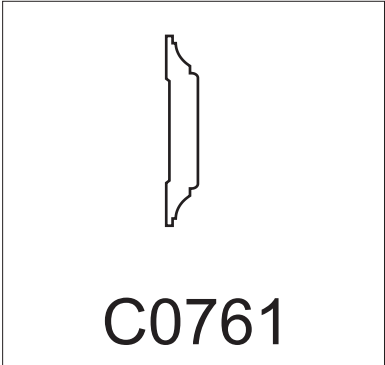
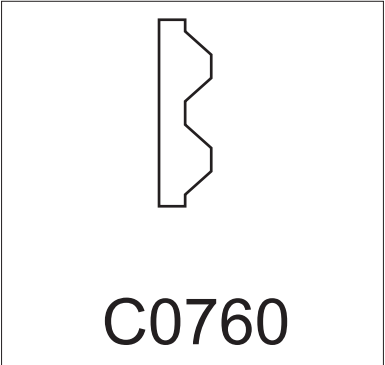
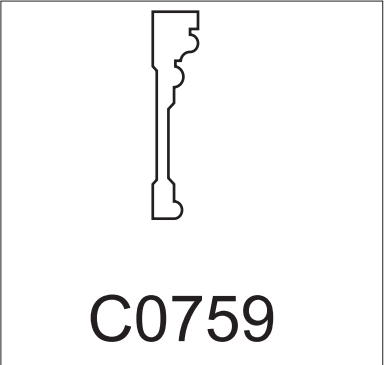

CHAIR RAILS 8/9

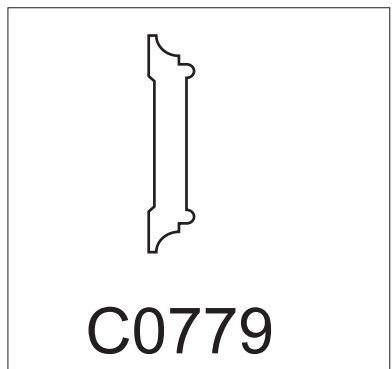
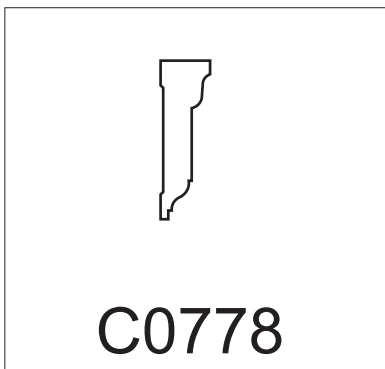
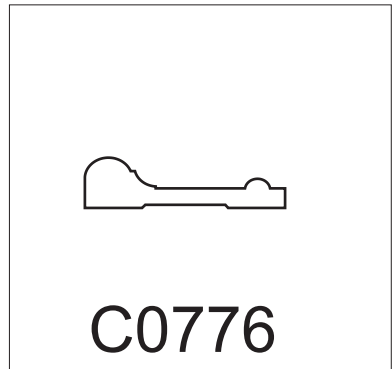
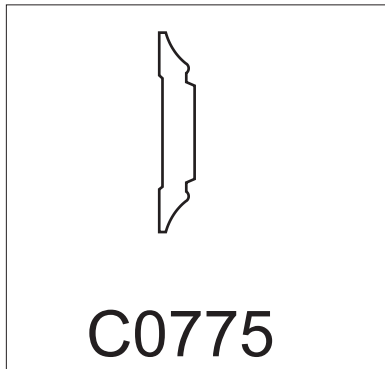
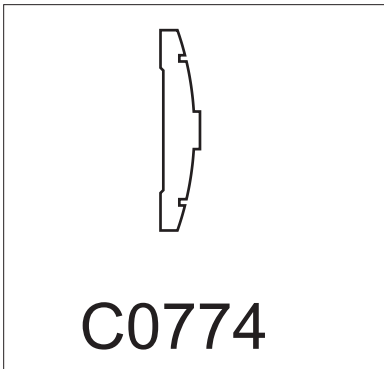
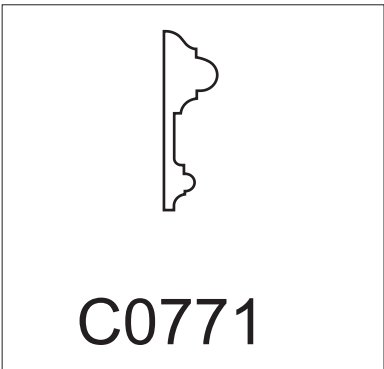
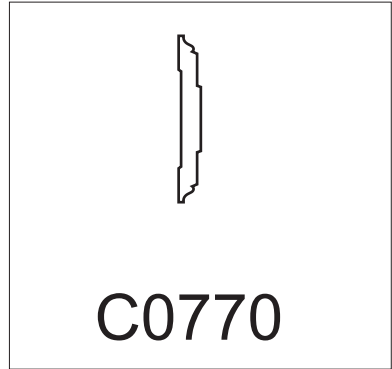
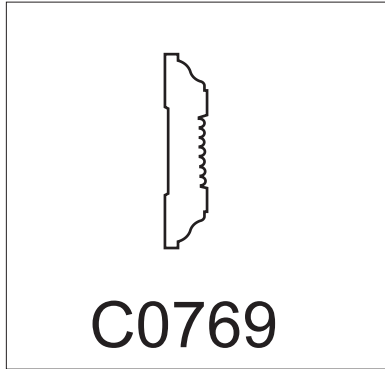
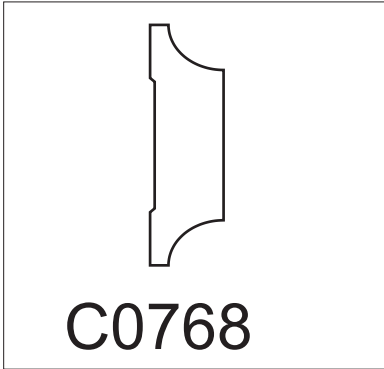

CHAIR RAILS 9/9



C0780



C0781

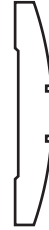

C0782



C0783

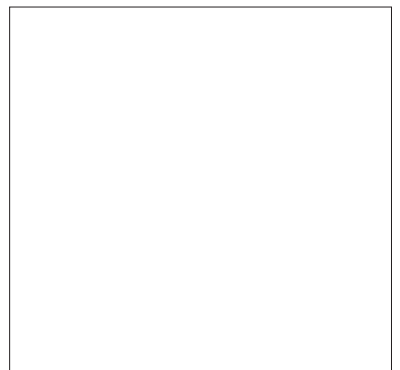
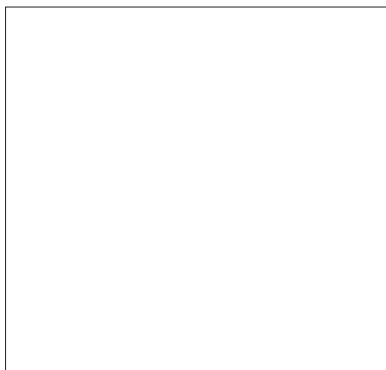
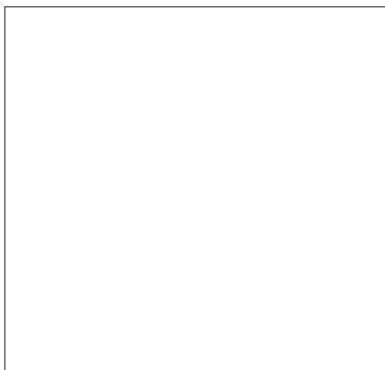
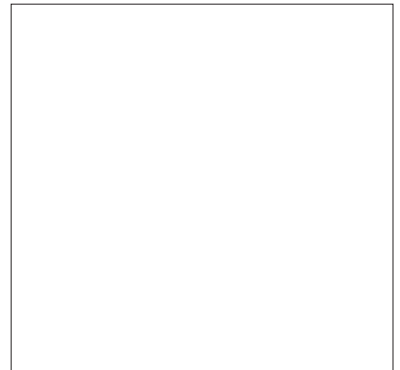
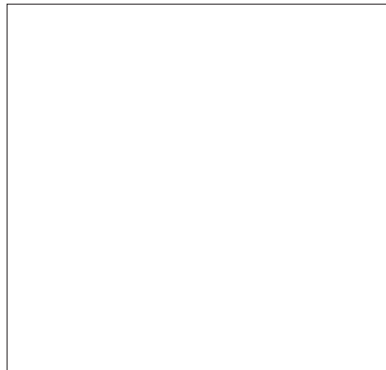
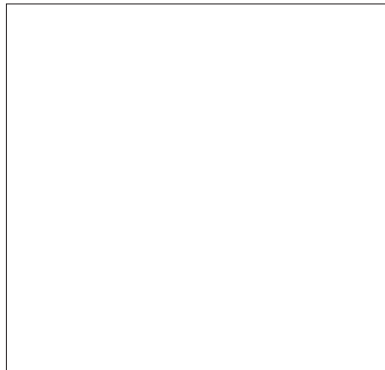
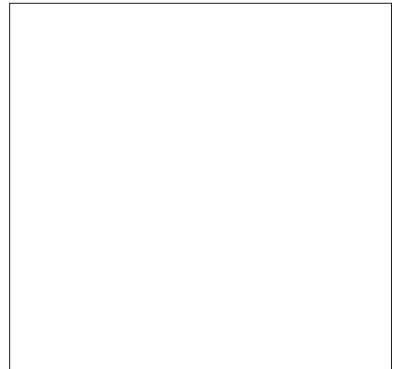
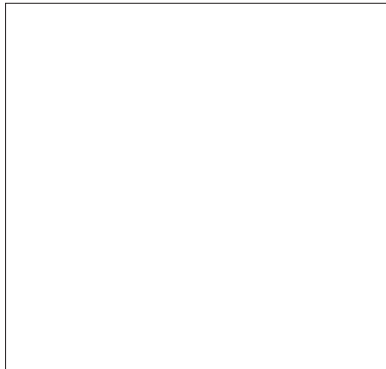
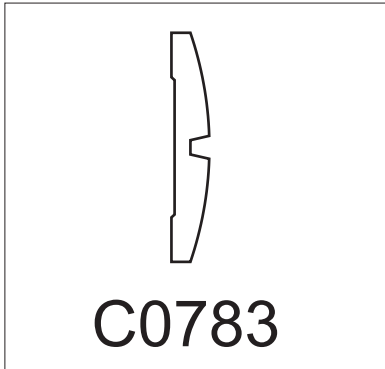
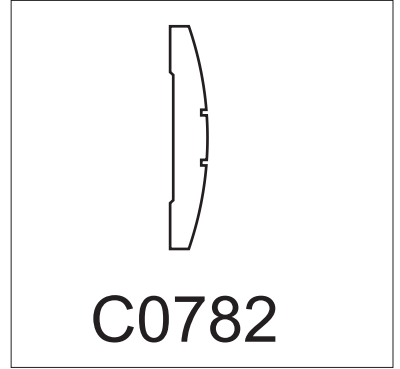
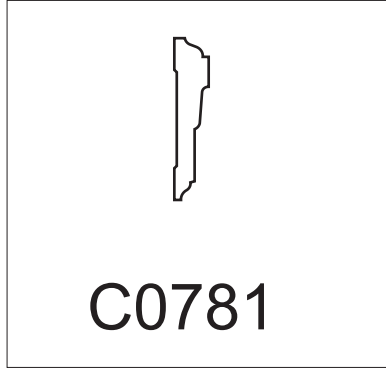
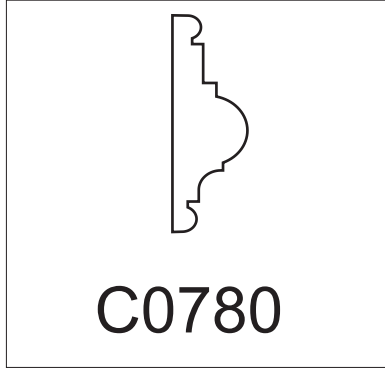

COVES 1/5

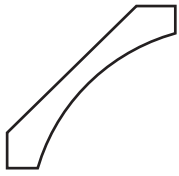

C0784



C0785

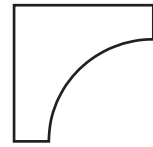

C0786

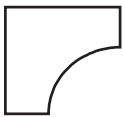

C0787

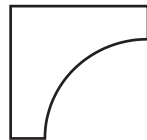

C0788



C0789

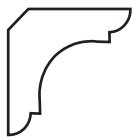

C0790



C0791

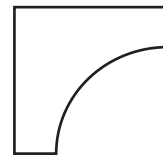

C0792

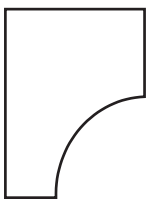

C0793

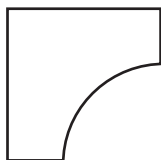

C0794



C0795

COVES 2/5

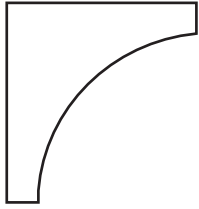

C0796

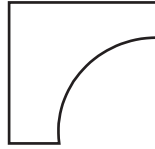

C0797

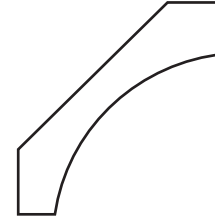

C0798

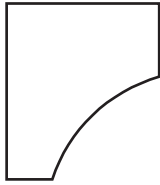

C0799



C0800



C0801



C0802

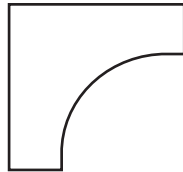

C0803



C0804

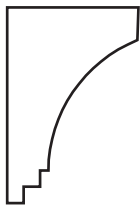

C0805

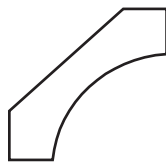

C0806

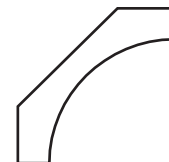

C0807

COVES 3/5

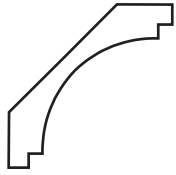

C0808

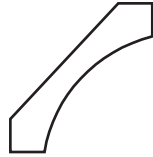

C0809

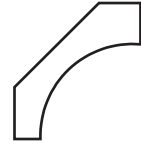

C0810

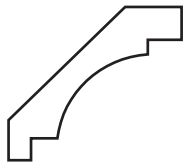

C0811



C0812

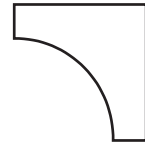

C0813

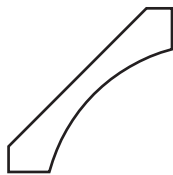

C0814

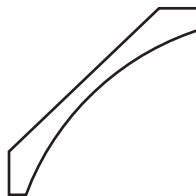

C0815

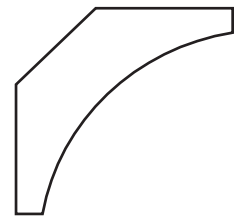

C0816

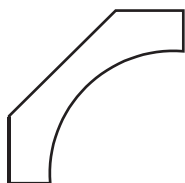

C0817

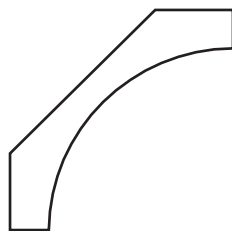

C0818

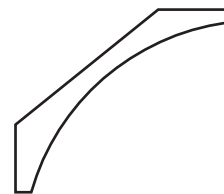

C0819

COVES 4/5



C0820

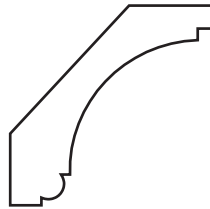

C0821

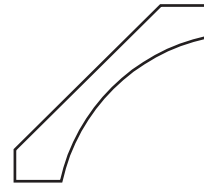

C0822

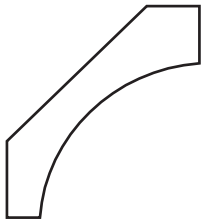

C0823

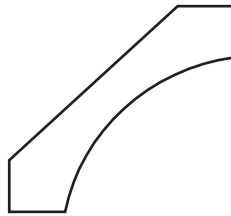

C0824

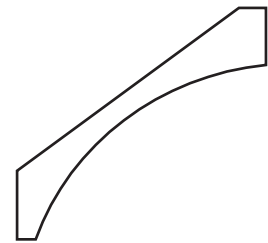

C0825

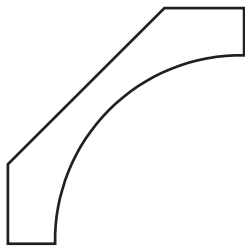

C0826

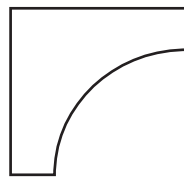

C0827



C0828

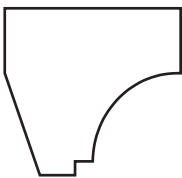

C0829

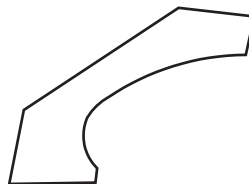

C0830

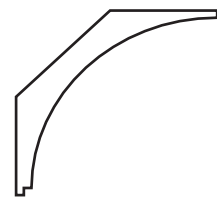

C0831

COVES 5/5

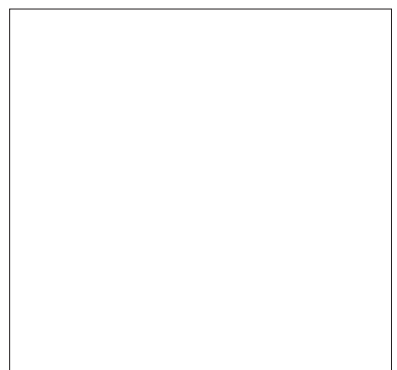
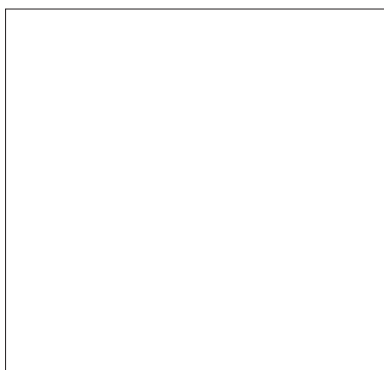
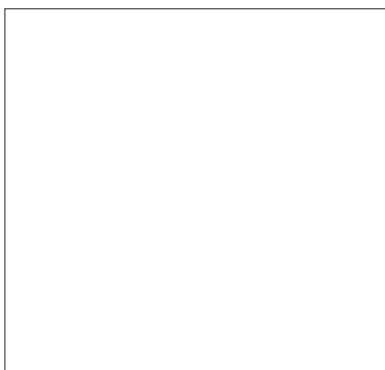
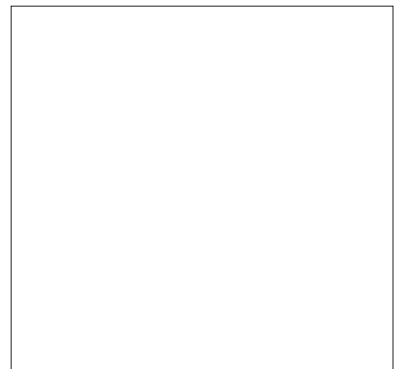
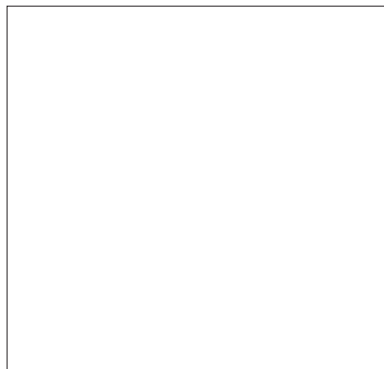
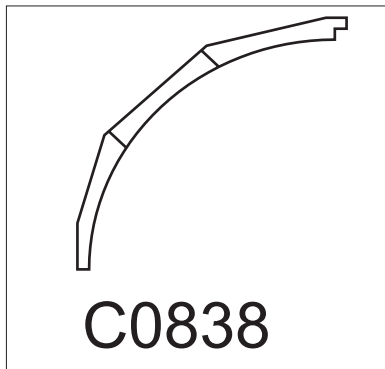
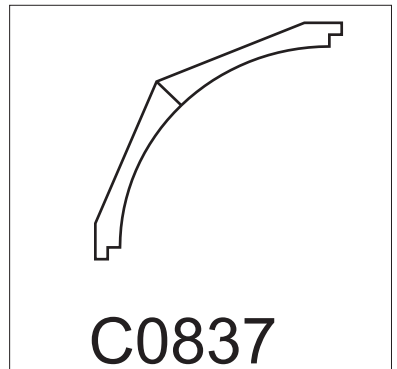
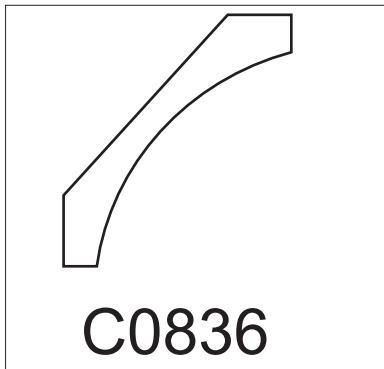
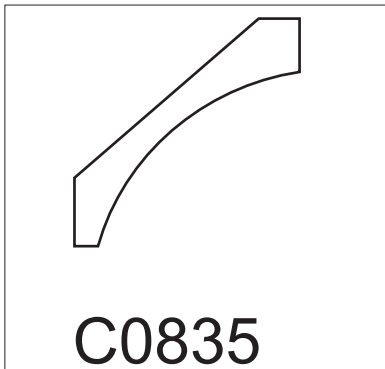
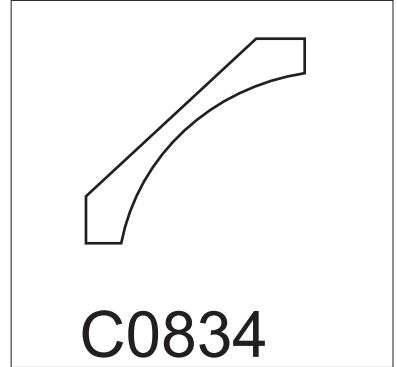
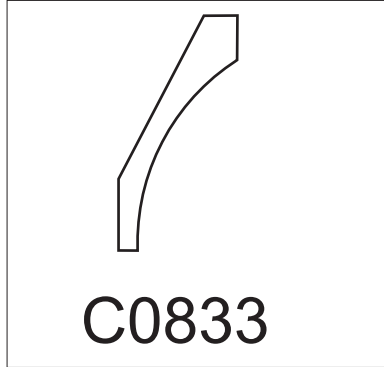
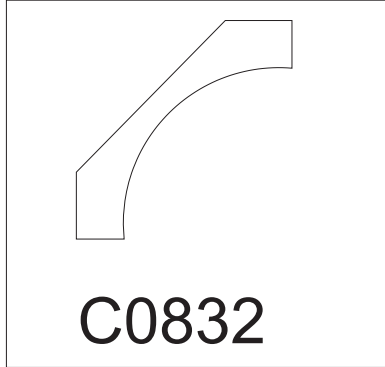

CROWNS 1/9

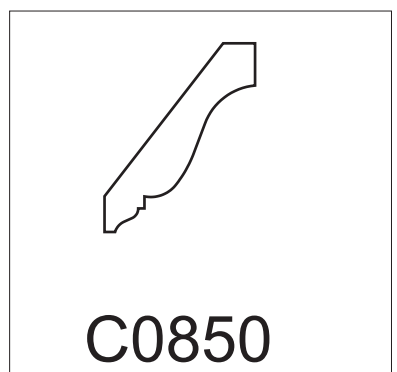
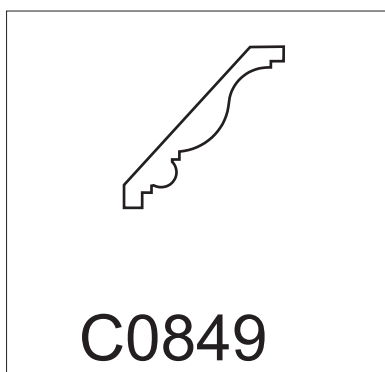
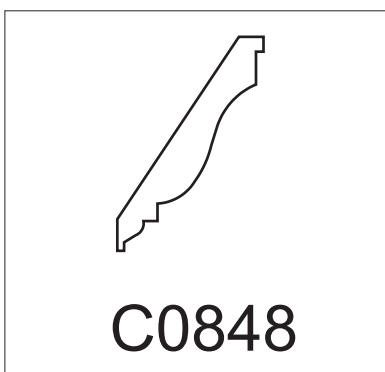
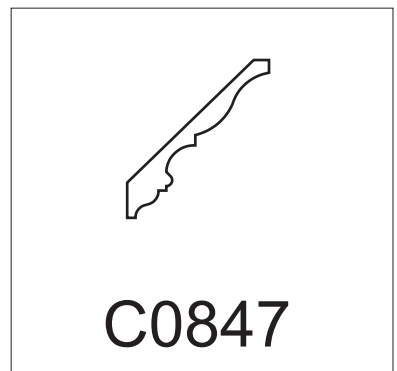
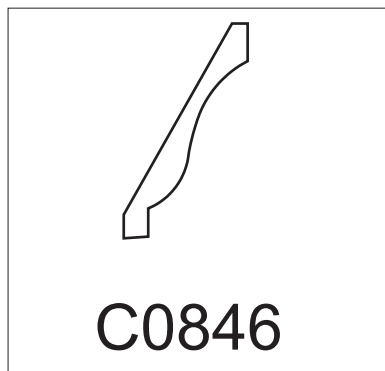
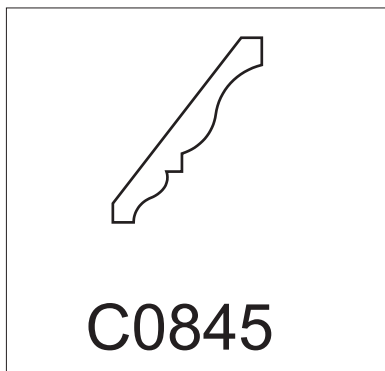
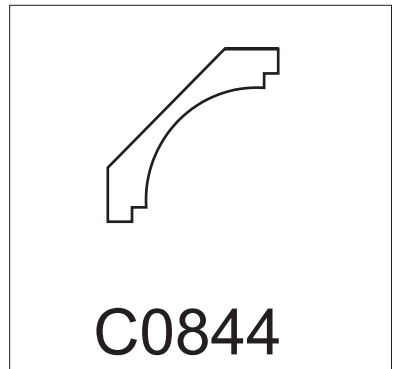
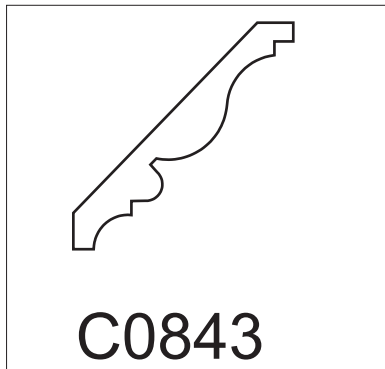
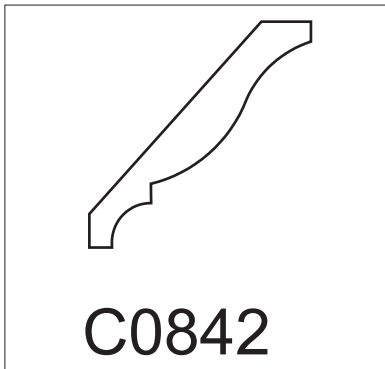
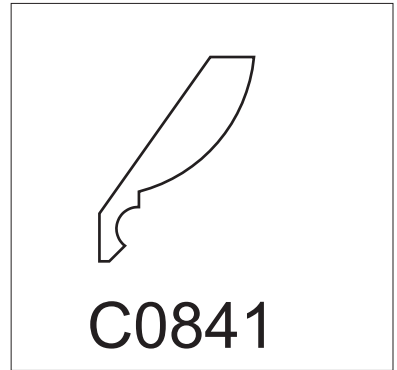
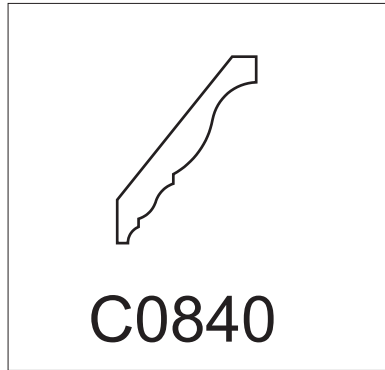
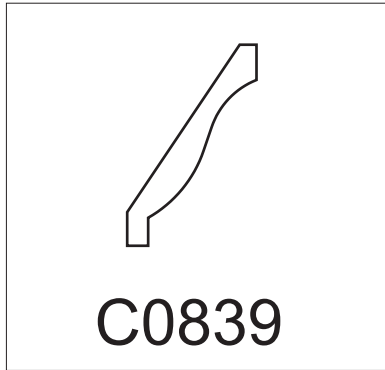

CROWNS 2/9



C0851



C0852

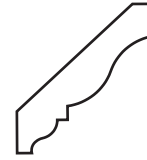

C0853



C0854



C0855

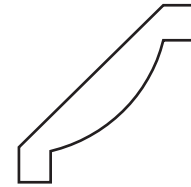

C0856

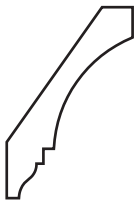

C0857

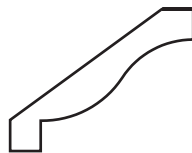

C0858

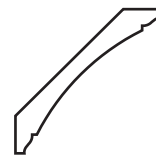

C0859

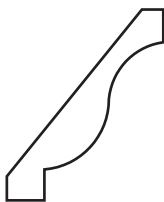

C0860



C0861

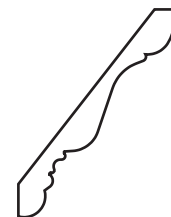

C0862

CROWNS 3/9

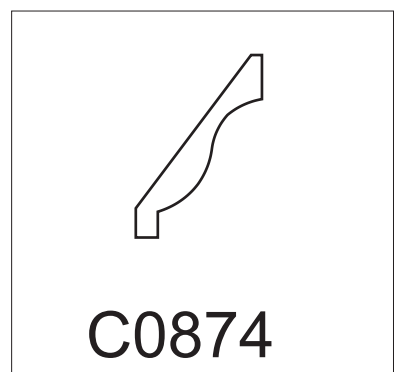
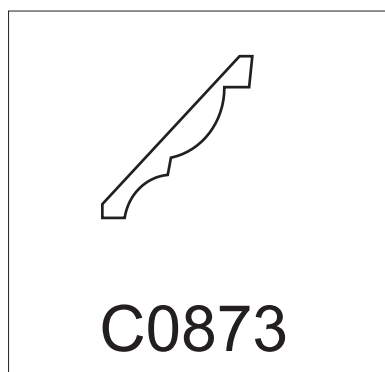
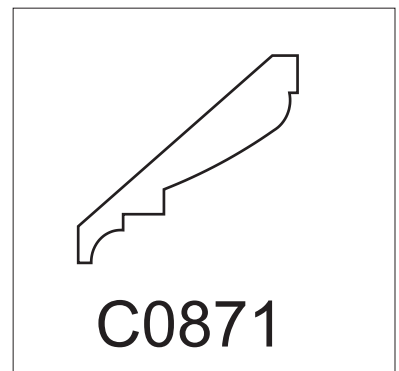
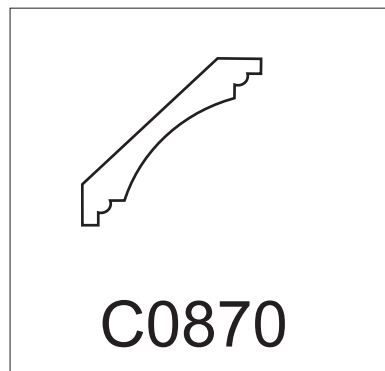
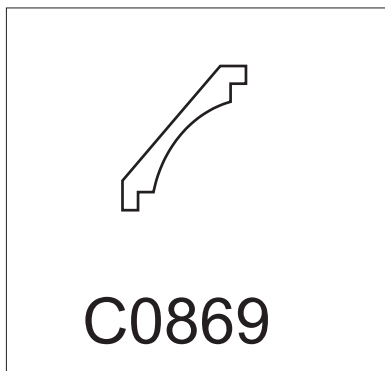
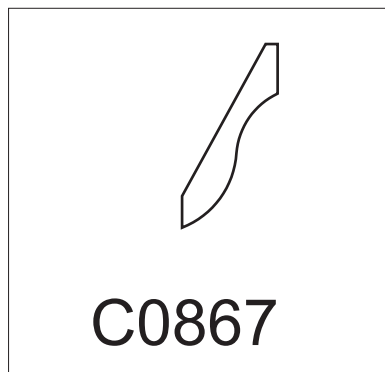
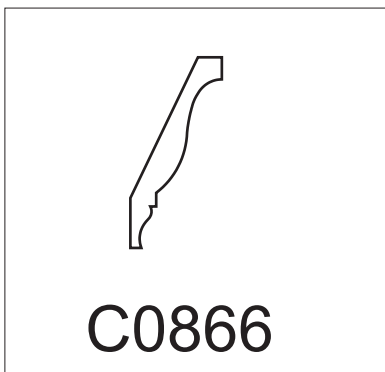
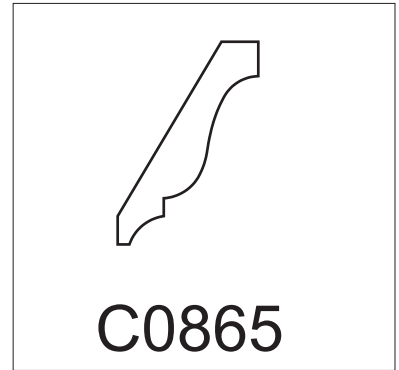
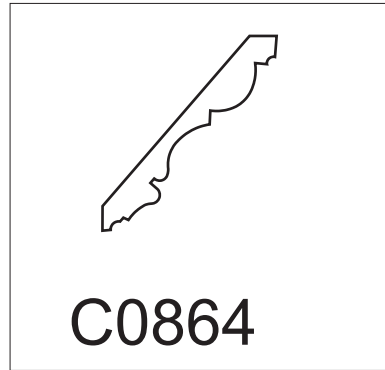

CROWNS 4/9

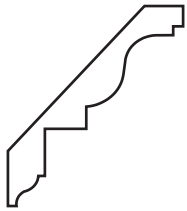

C0875

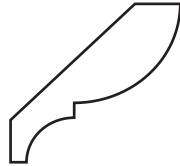

C0876

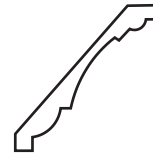

C0877

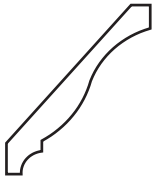

C0878

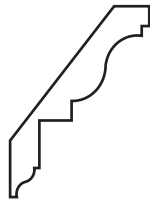

C0879

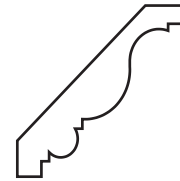

C0880

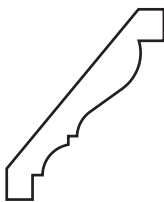

C0881

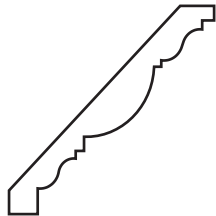

C0882

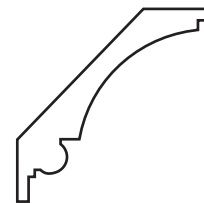

C0883

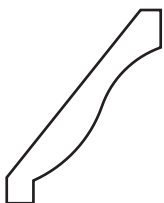

C0884

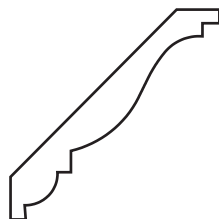

C0885



C0886

CROWNS 5/9

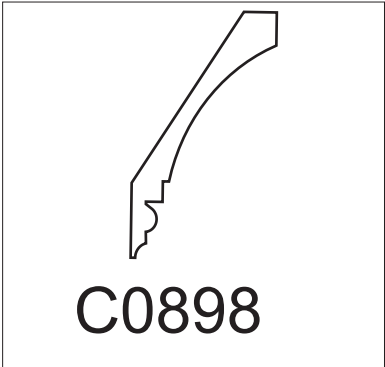
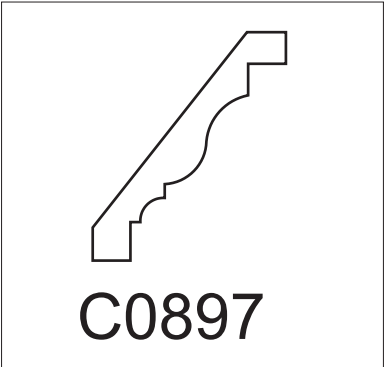
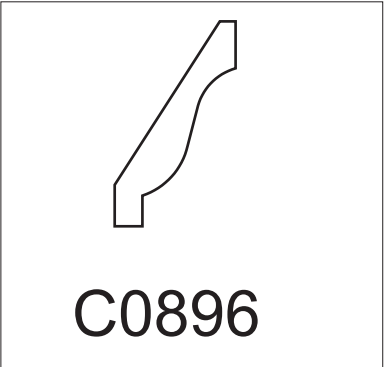
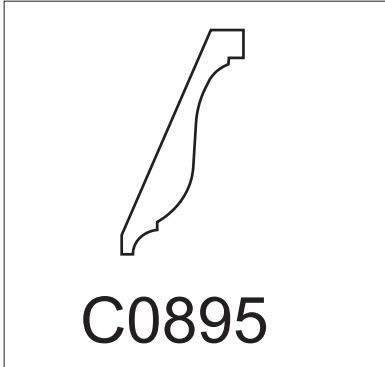
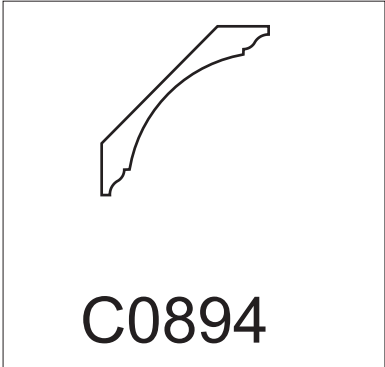
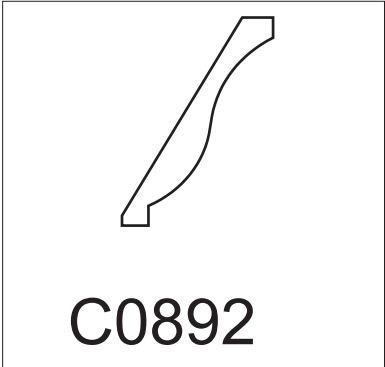
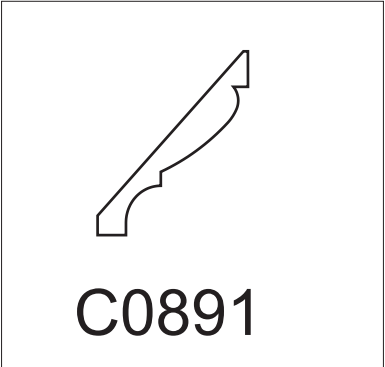
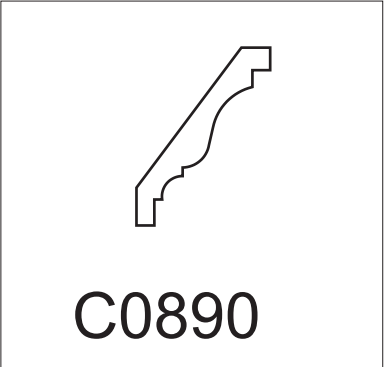
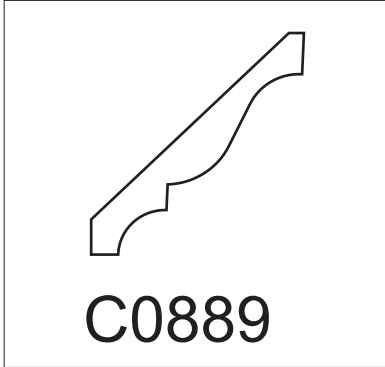
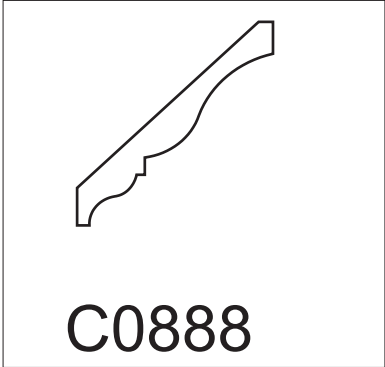
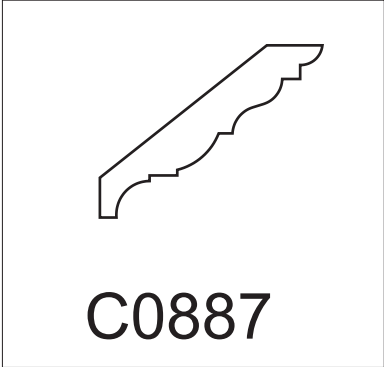

CROWNS 6/9

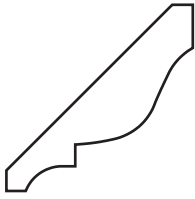

C0899

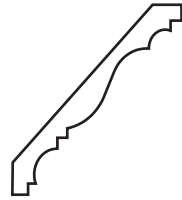

C0900

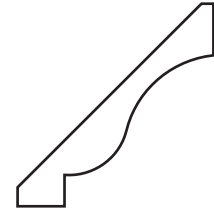

C0901

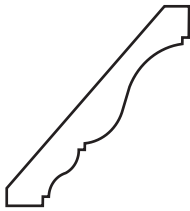

C0902

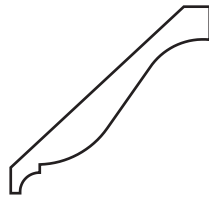

C0903

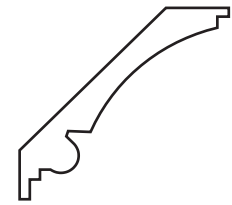

C0904



C0905

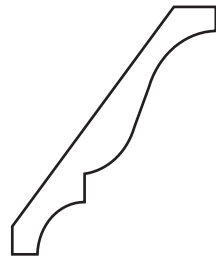

C0906

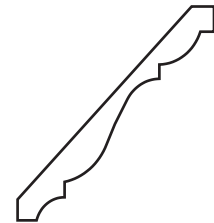

C0907

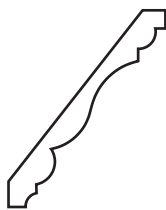

C0908

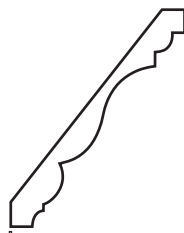

C0909

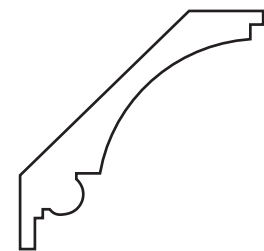

C0910

CROWNS 7/9

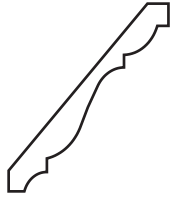

C0911



C0912



C0913

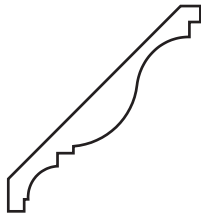

C0914



C0915



C0916

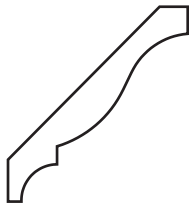

C0917

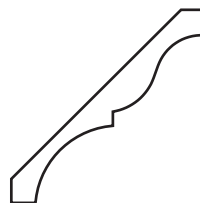

C0918



C0919



C0920

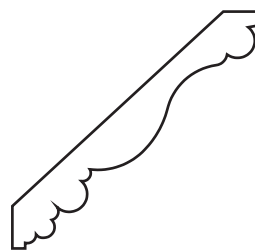

C0921



C0922

CROWNS 8/9



C0923

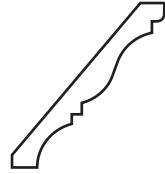

C0924



C0925

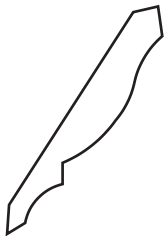

C0926

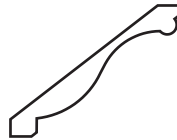

C0927

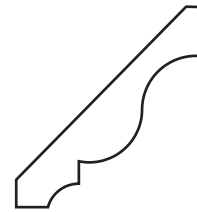

C0928



C0929

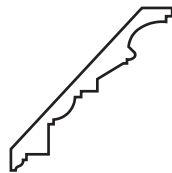

C0930

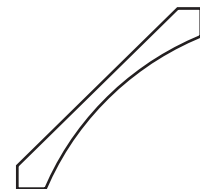

C0931

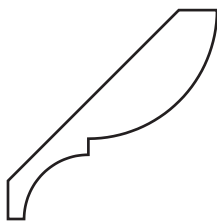

C0932

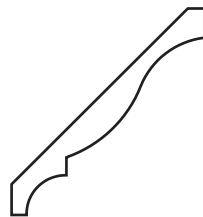

C0933

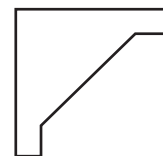

C0934

CROWNS 9/9

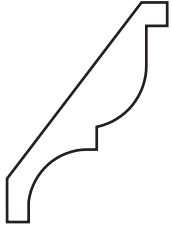

C0935

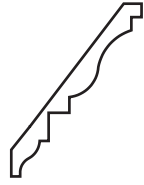

C0936

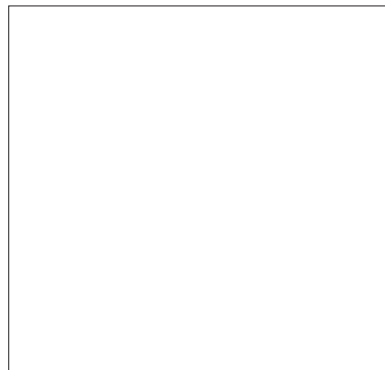
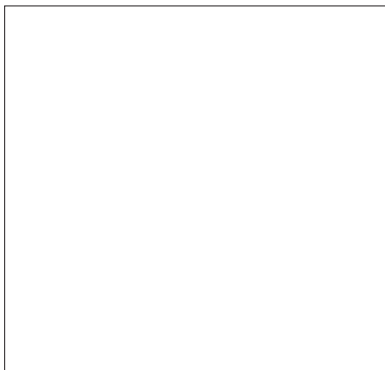
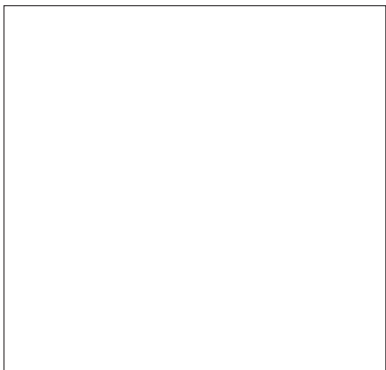
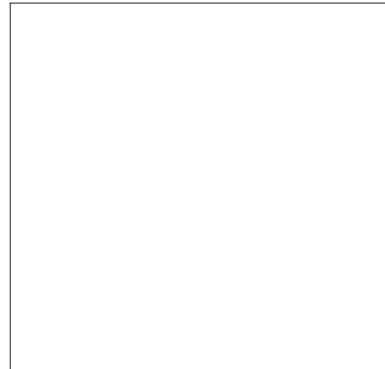
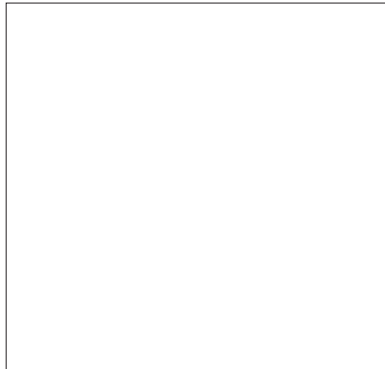
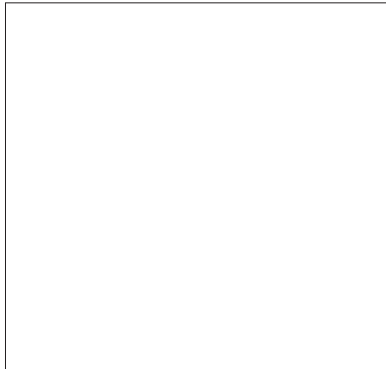
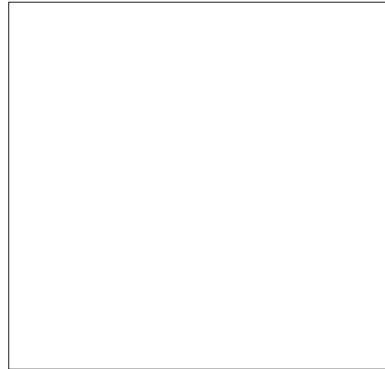
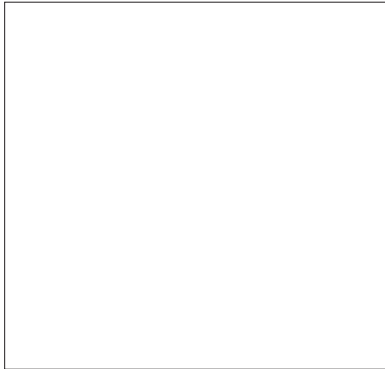
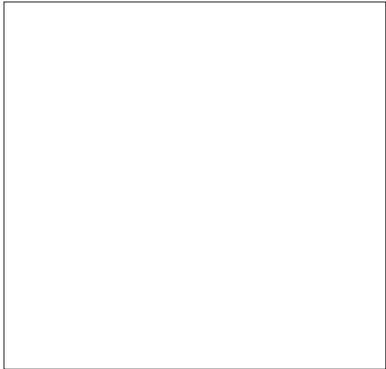
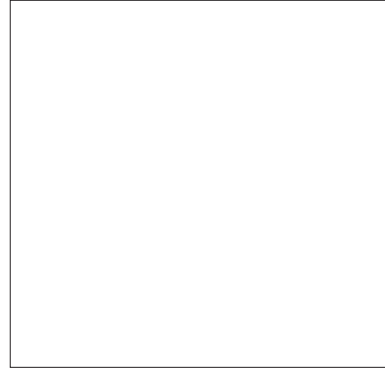
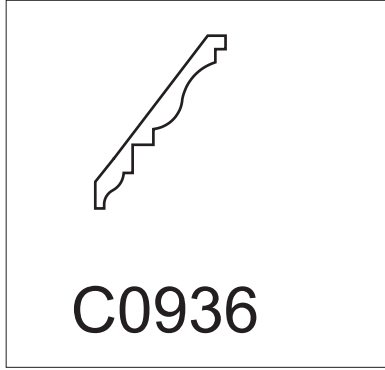
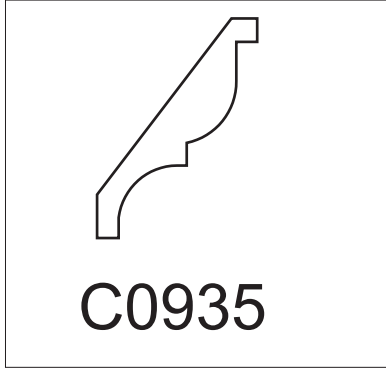

HANDRAILS & ROUNDS 1/8

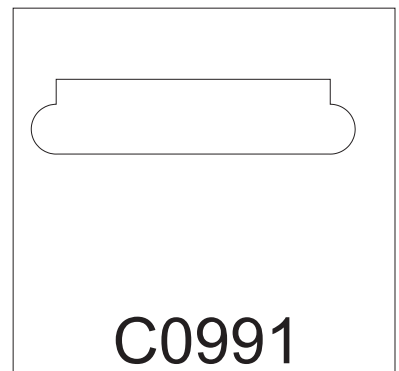
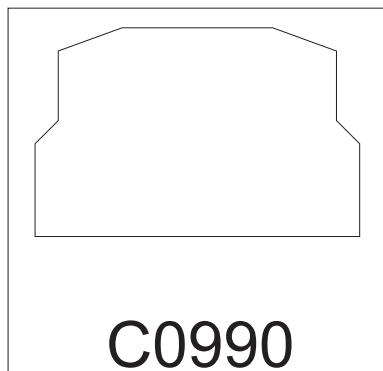
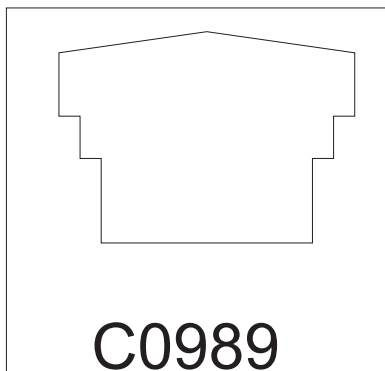
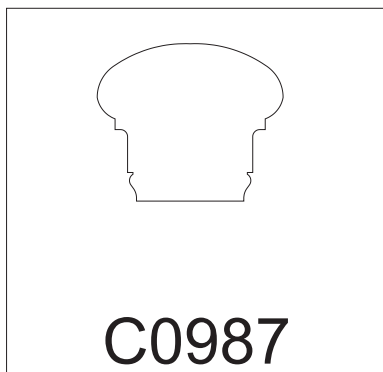
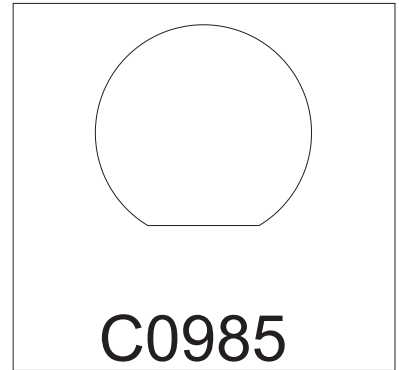
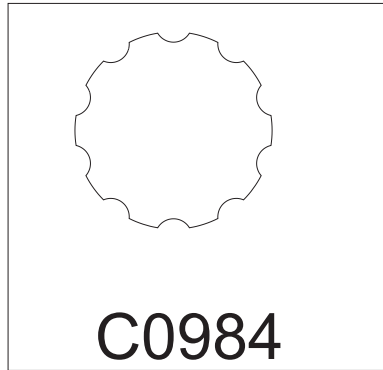
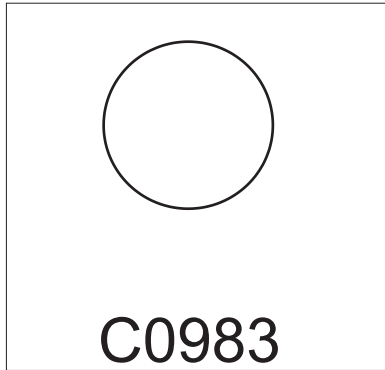

HANDRAILS & ROUNDS 2/8

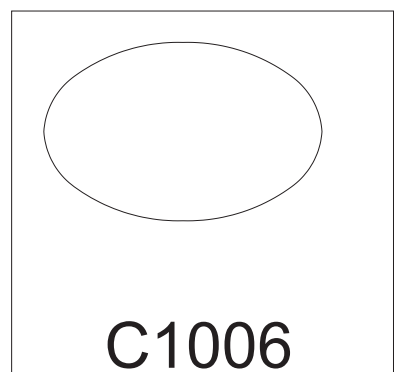
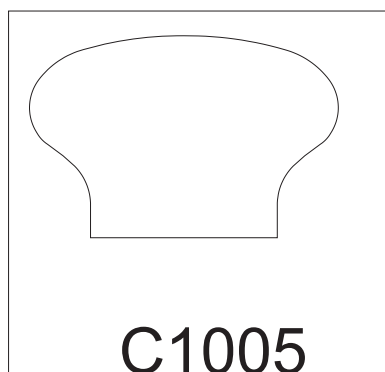
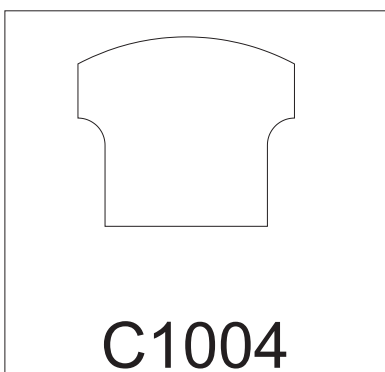
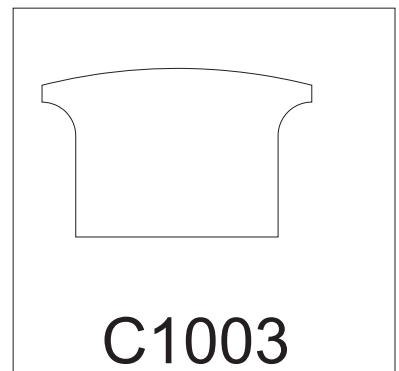
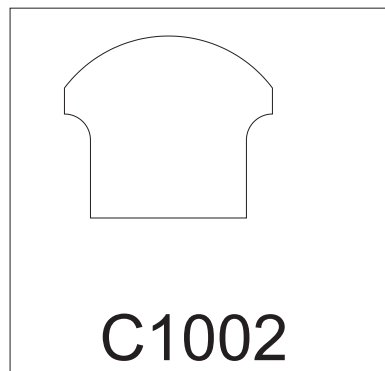
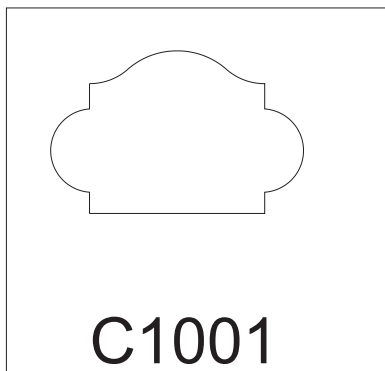
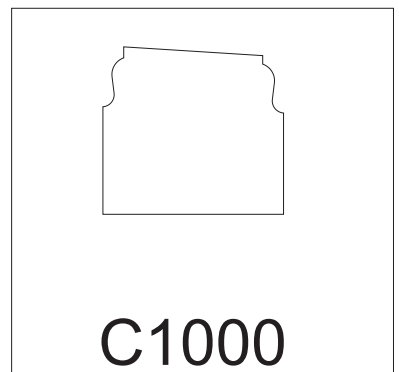
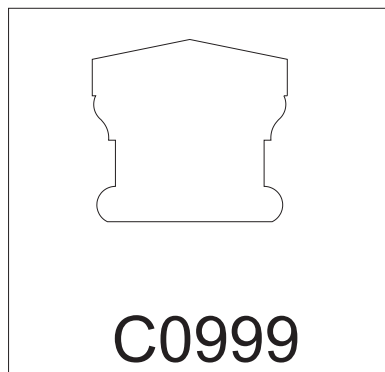
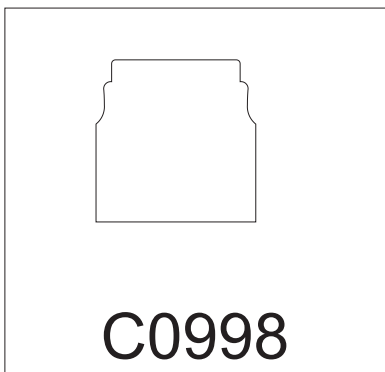
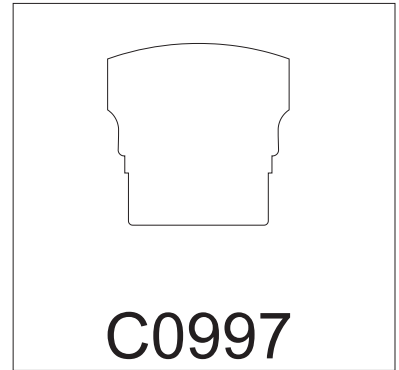
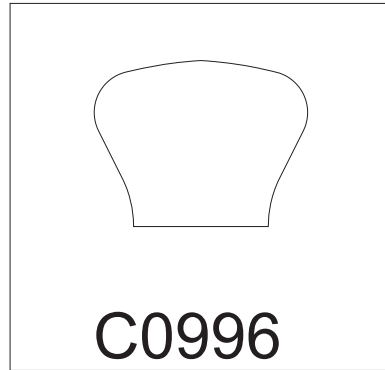

HANDRAILS & ROUNDS 3/8

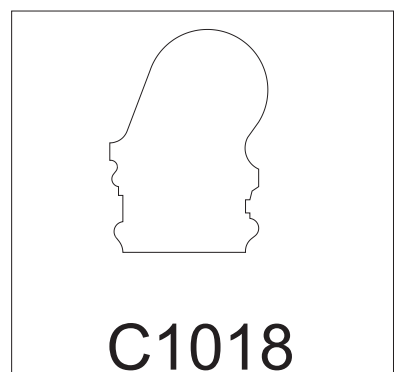
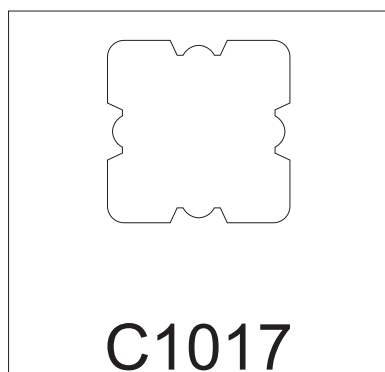
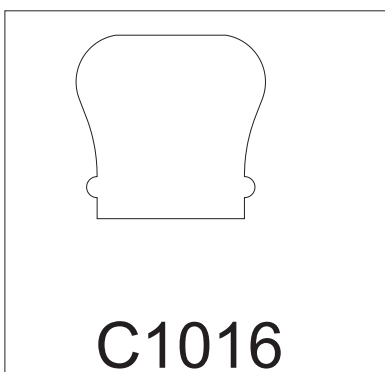
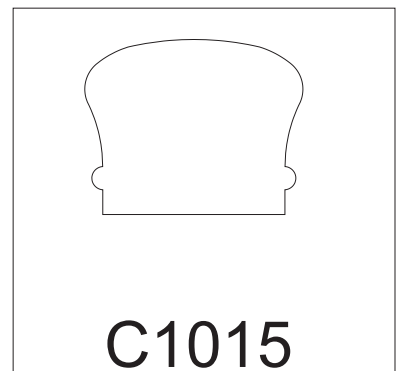
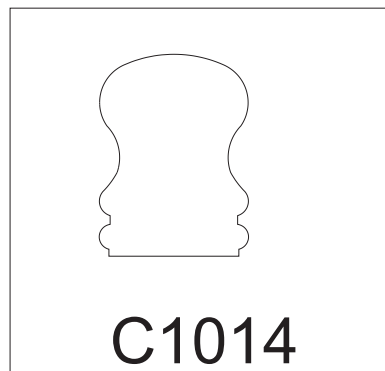
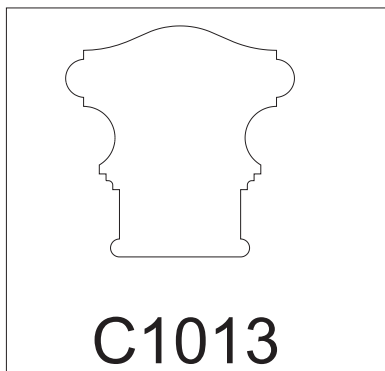
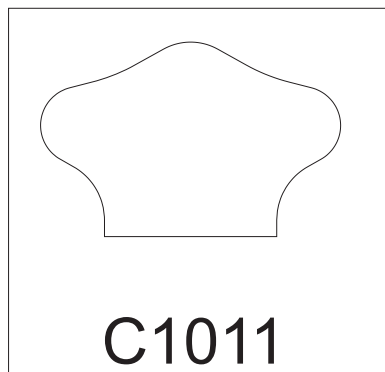
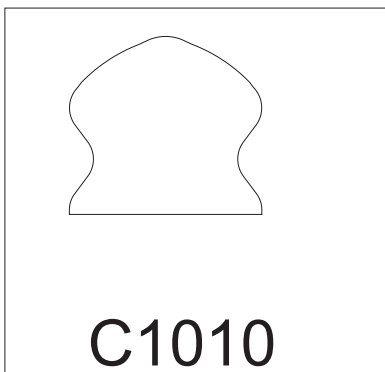
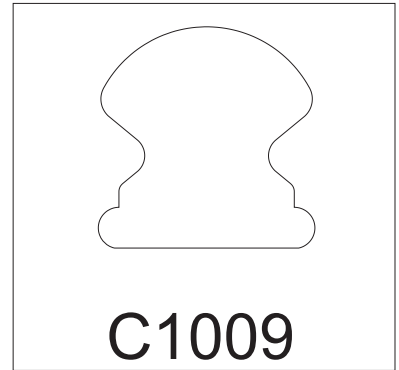
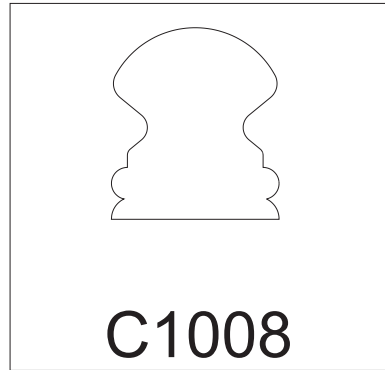
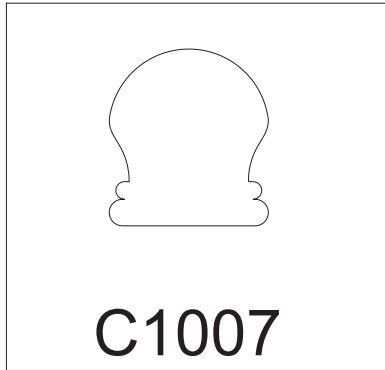

HANDRAILS & ROUNDS 4/8

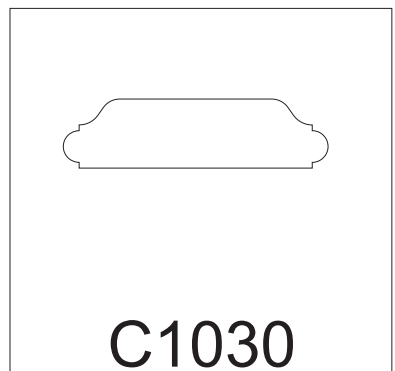
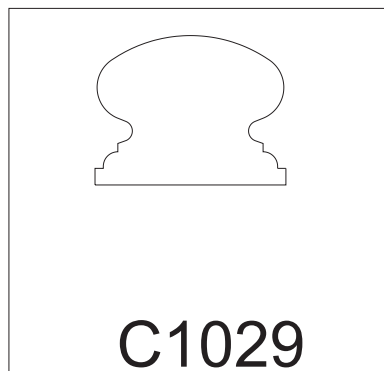
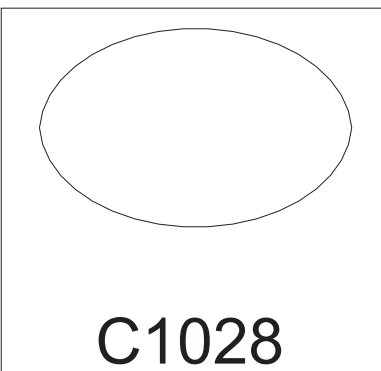
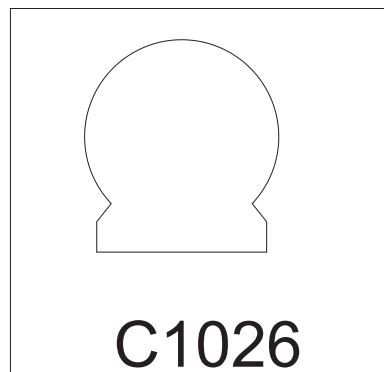
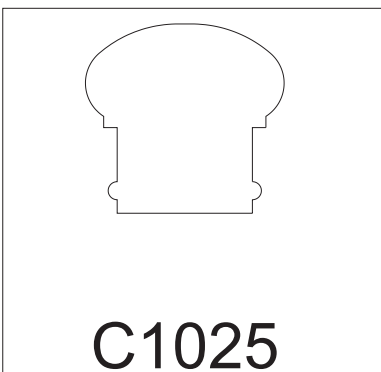
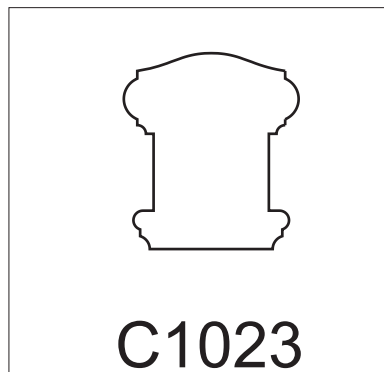
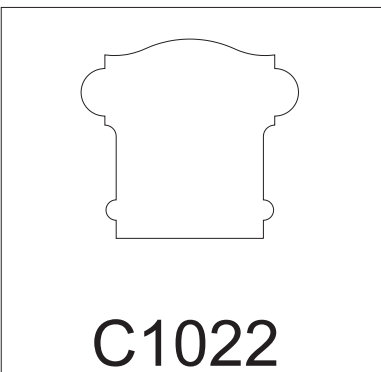
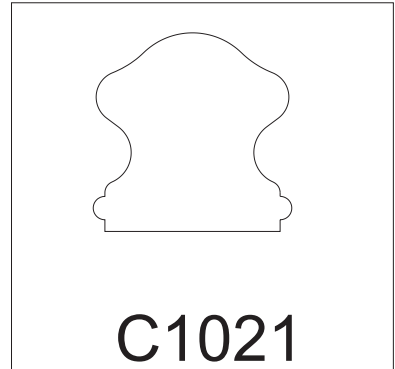
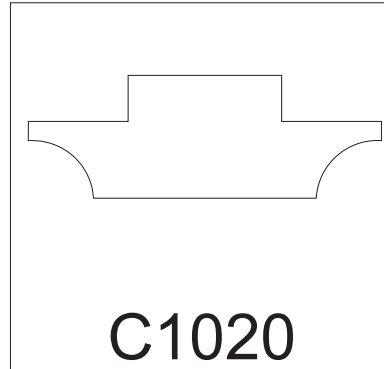
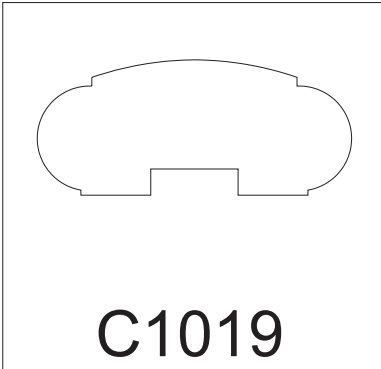

HANDRAILS & ROUNDS 5/8

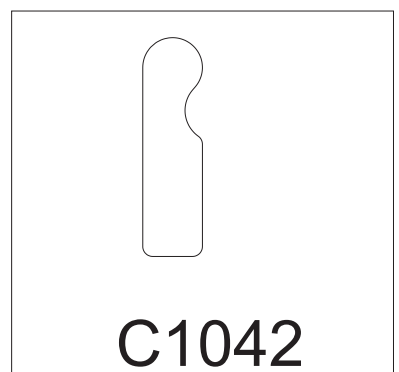
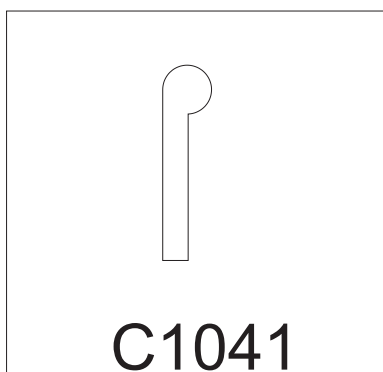
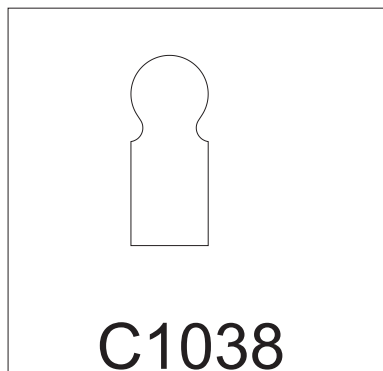
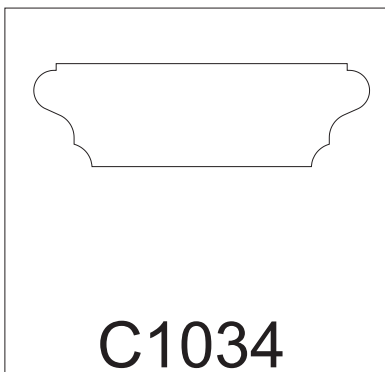
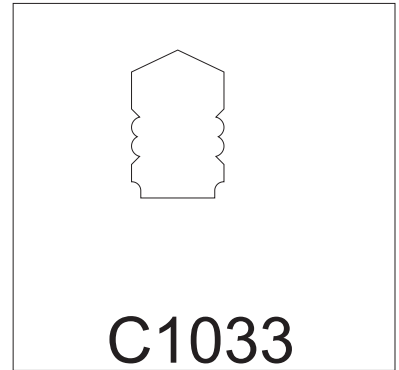
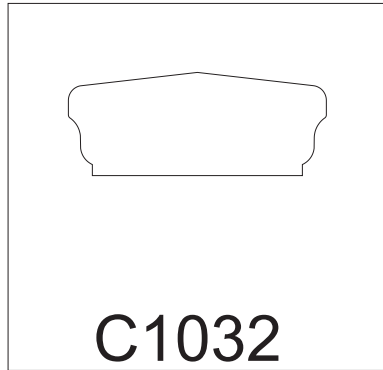
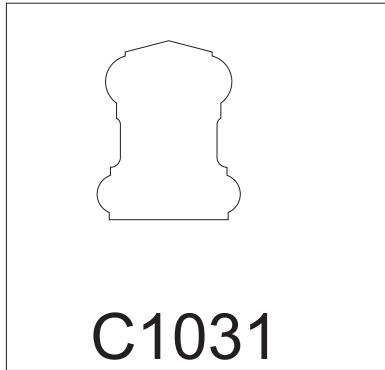

HANDRAILS & ROUNDS 6/8

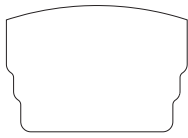

C1043



C1044

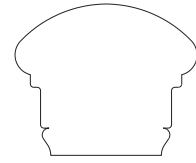

C1045



C1046



C1047



C1048

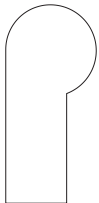

C1049

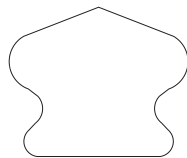

C1050

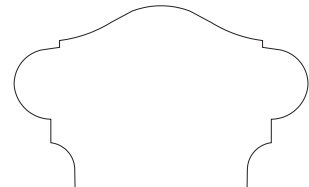

C1051

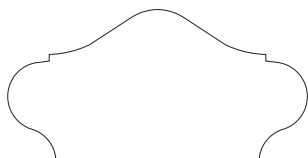

C1052

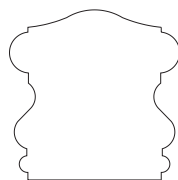

C1053

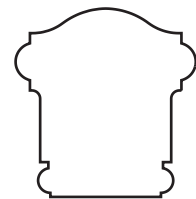

C1054

HANDRAILS & ROUNDS 7/8

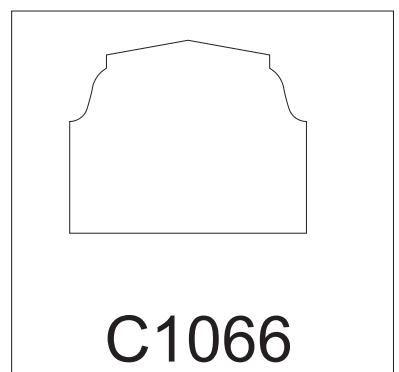
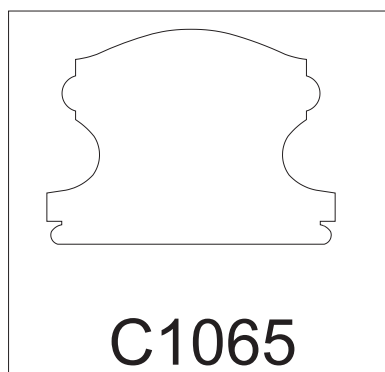
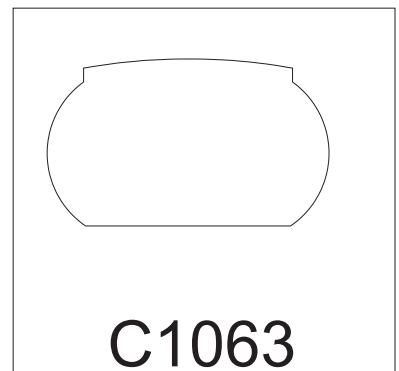
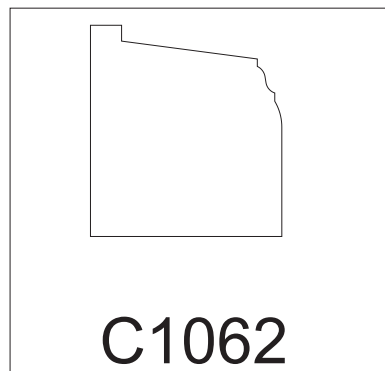
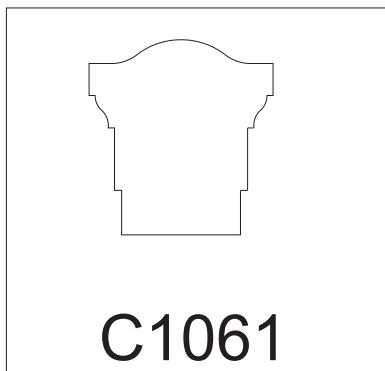
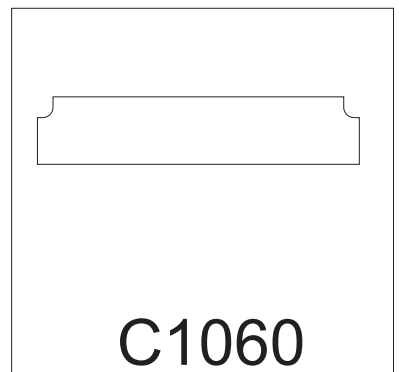
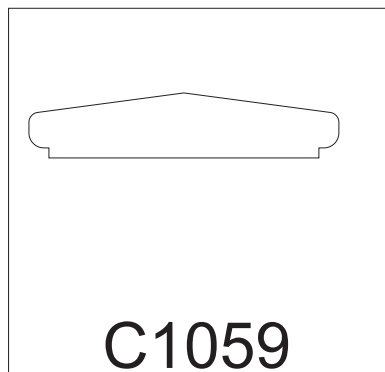
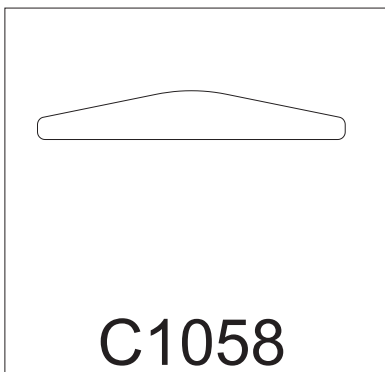
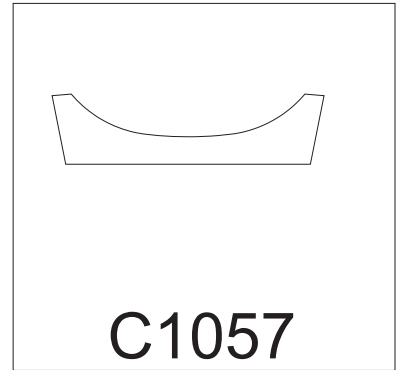
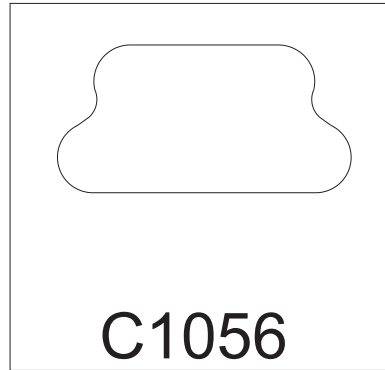

HANDRAILS & ROUNDS 8/8

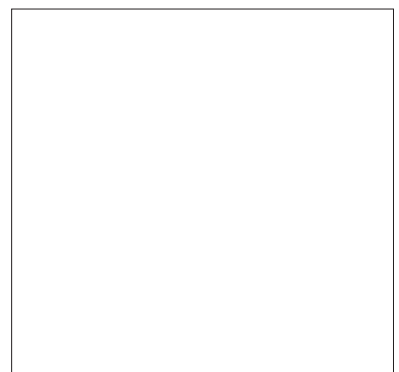
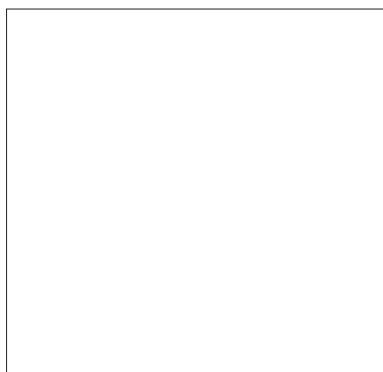
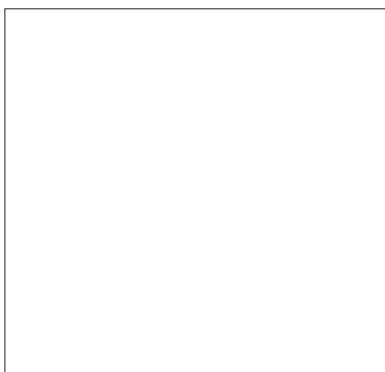
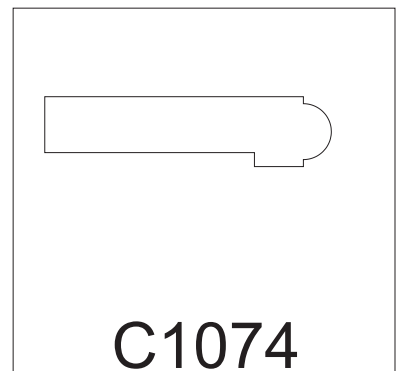
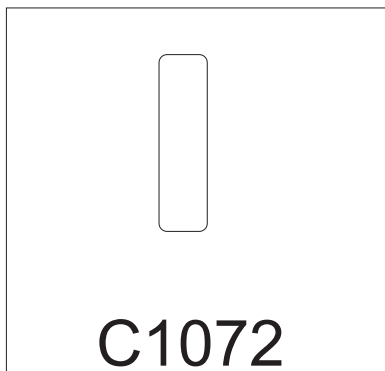
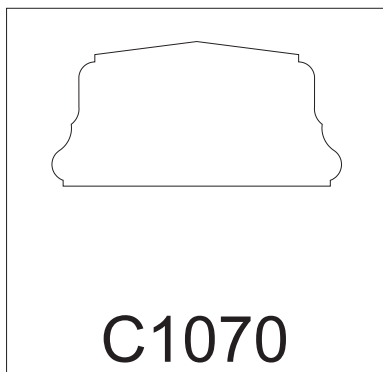
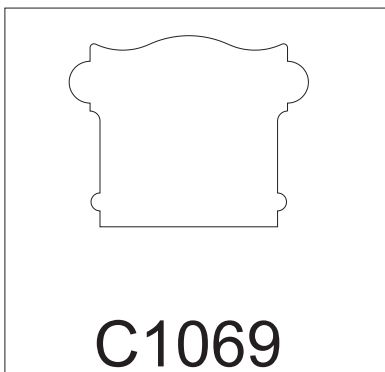
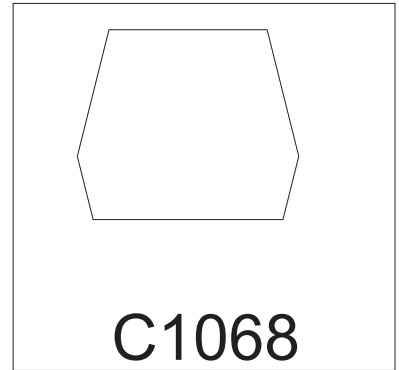
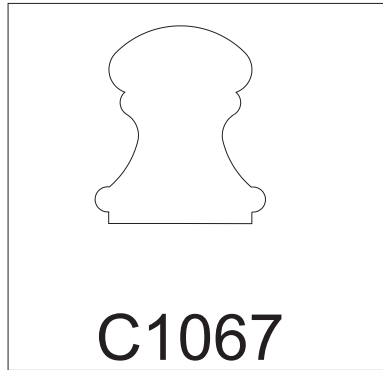
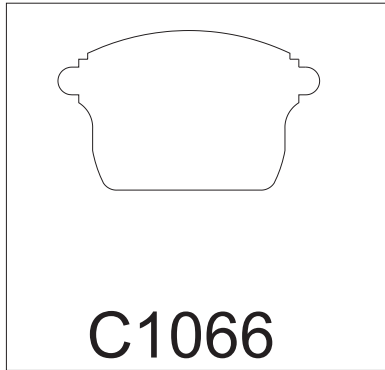

MOLDINGS 1/1

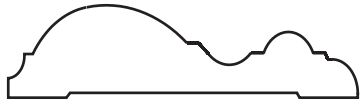

C1076

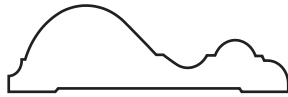

C1077



C1078

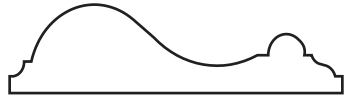

C1079

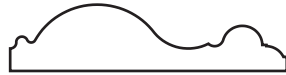

C1080

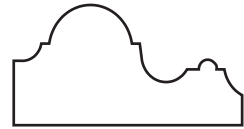

C1081



C1082



C1083



C1084



C1085

BULLNOSE 1/3

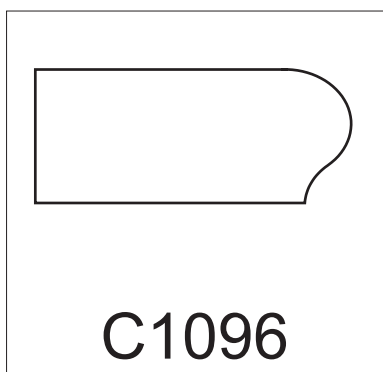
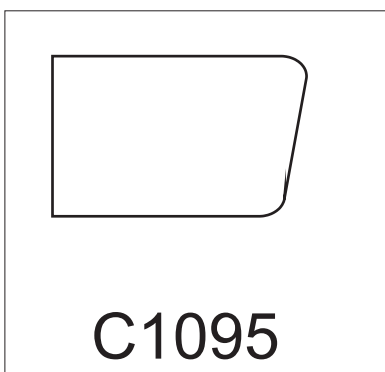
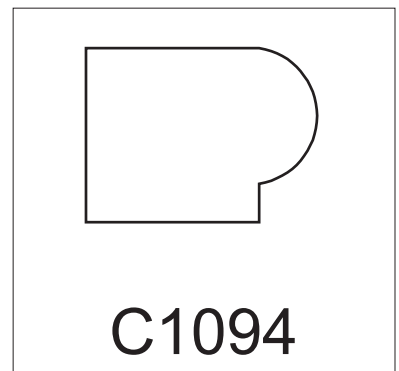
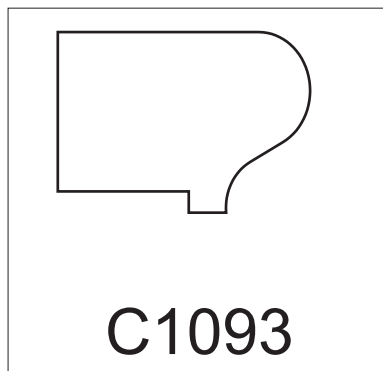
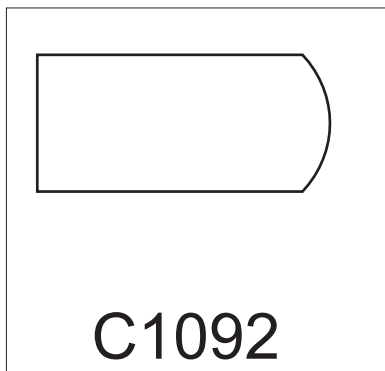
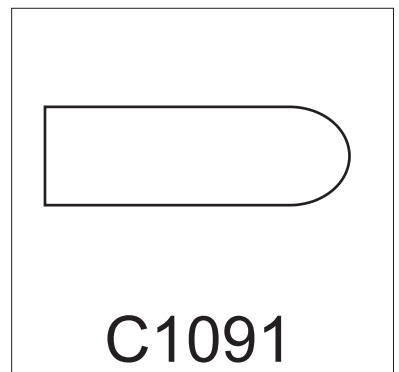
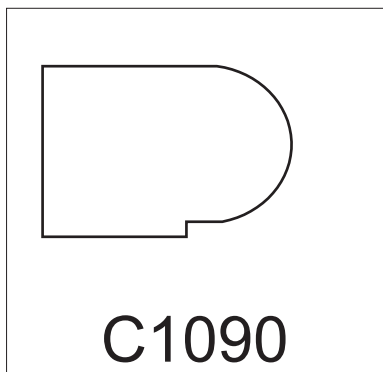
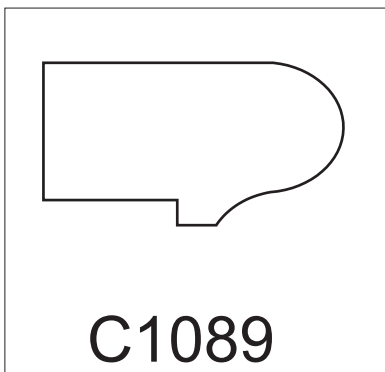
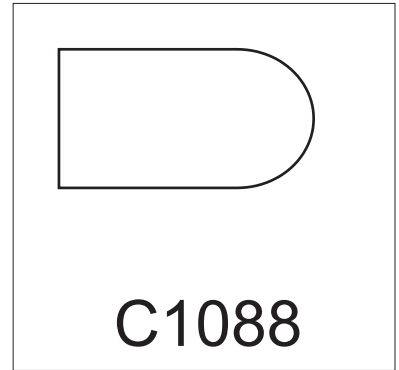
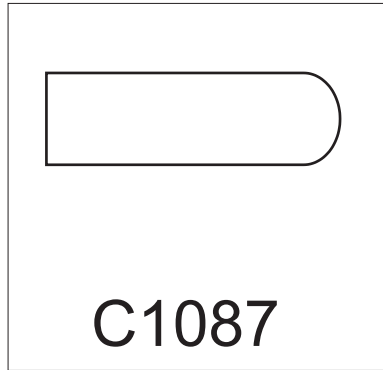
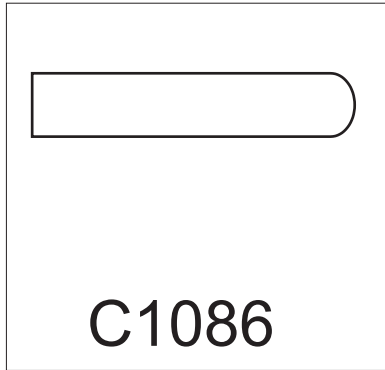

BULLNOSE 2/3

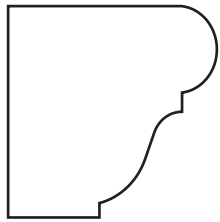

C1098



C1099

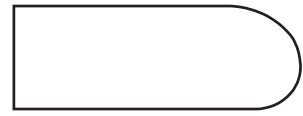

C1200

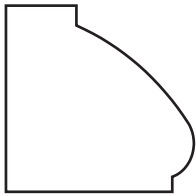

C1201

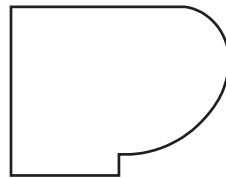

C1202



C1203

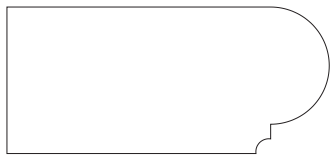

C1204

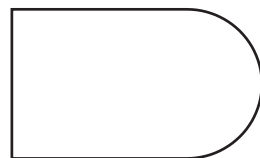

C1205



C1206



C1207

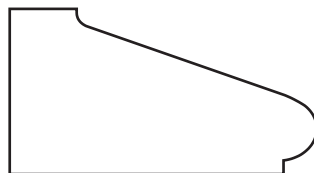

C1208



C1209

BULLNOSE 3/3

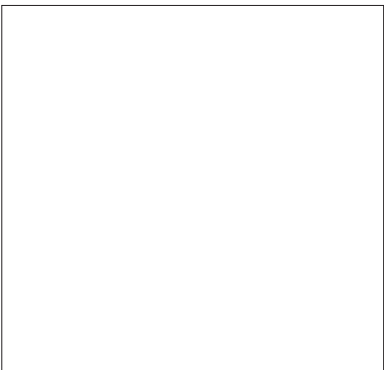
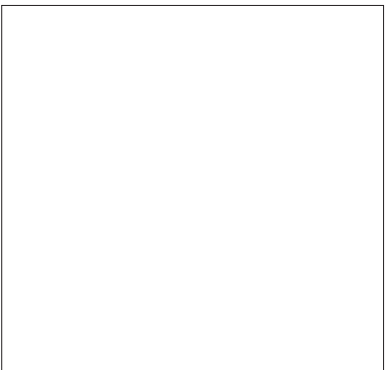
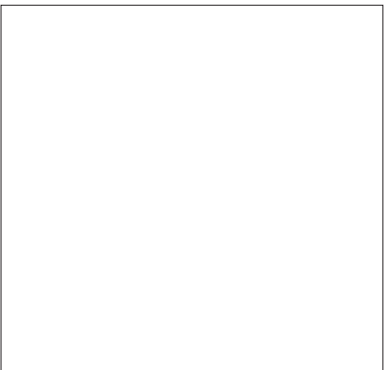
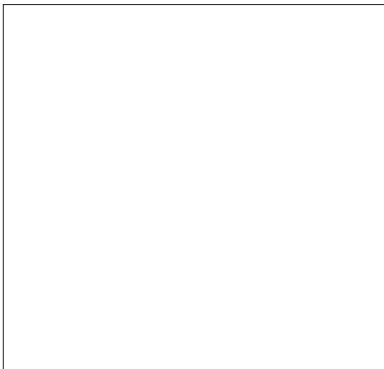
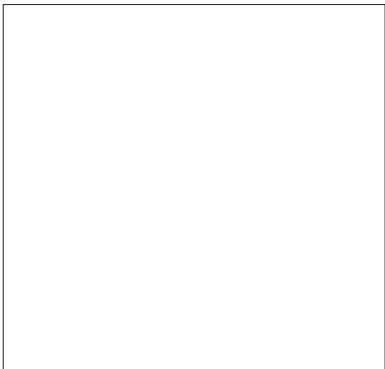
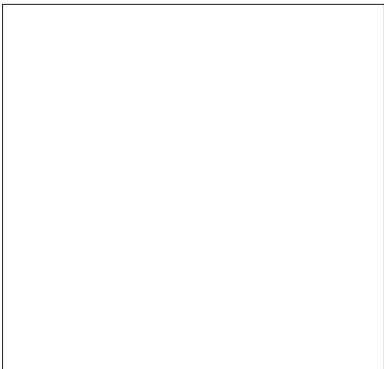
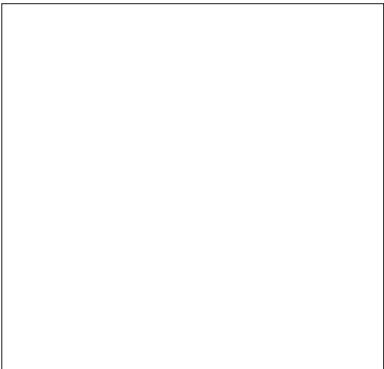
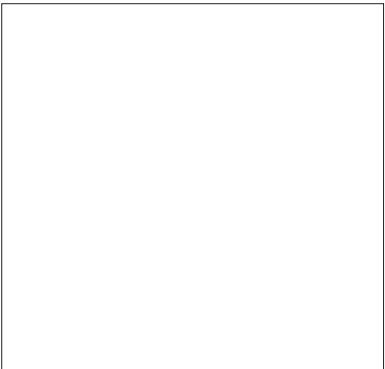
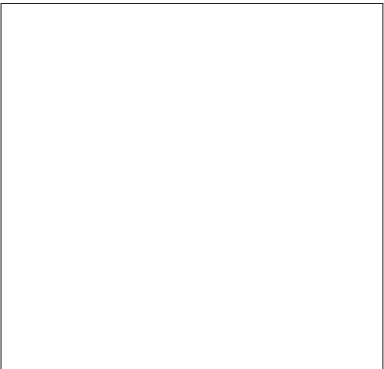
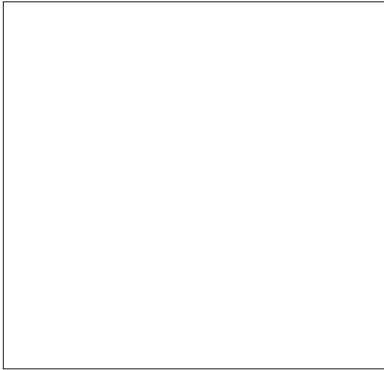
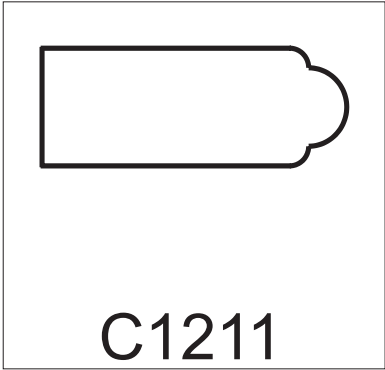
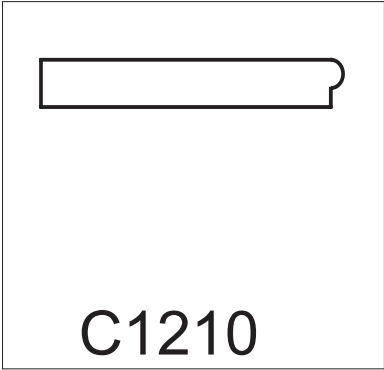

OUTSIDE CORNERS 1/2

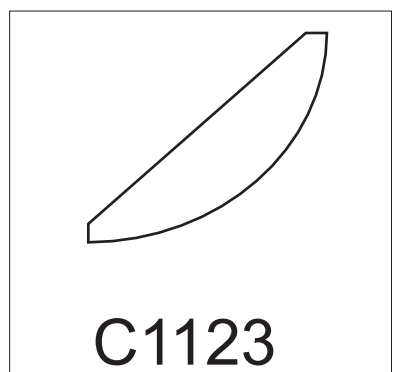
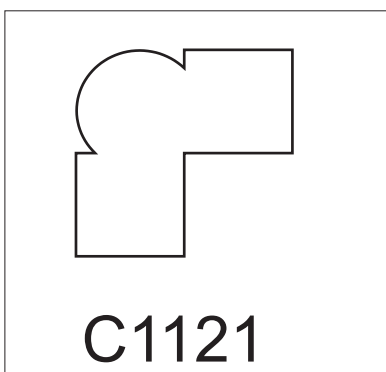
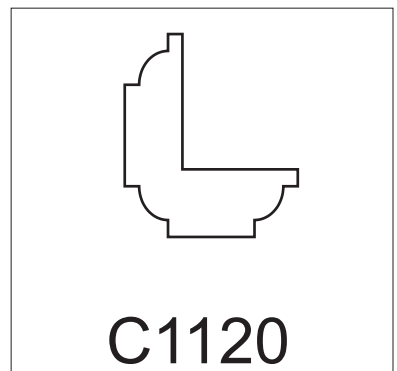
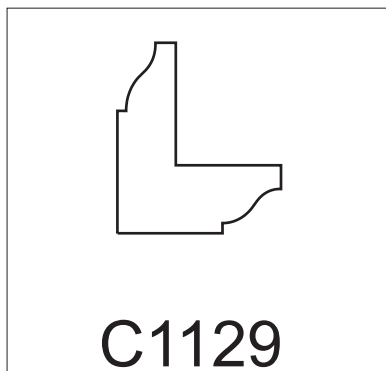
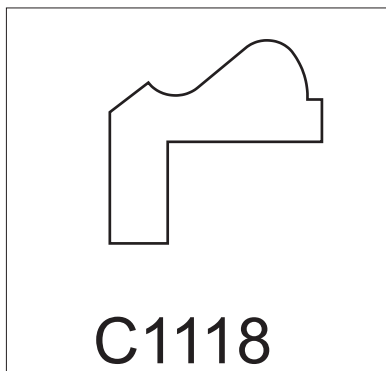
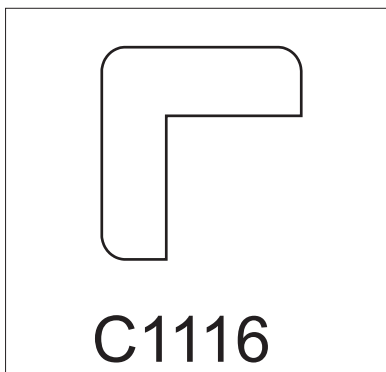
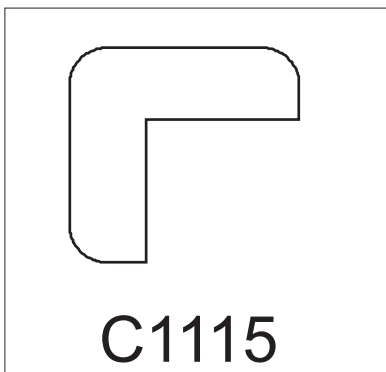
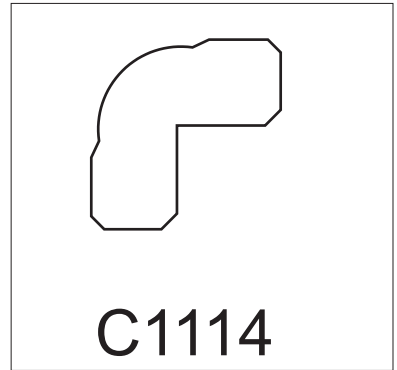
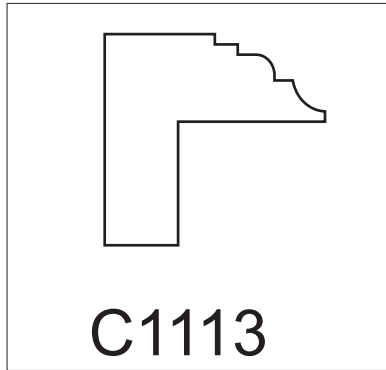
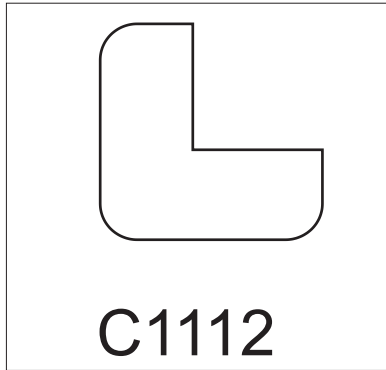

OUTSIDE CORNERS 2/2

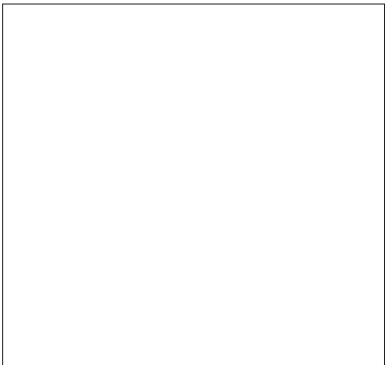
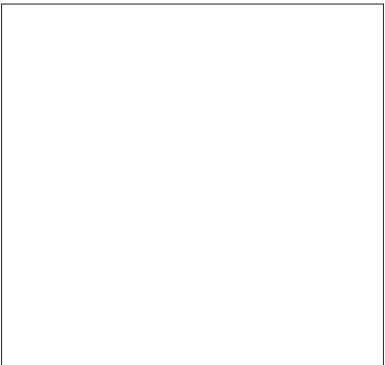
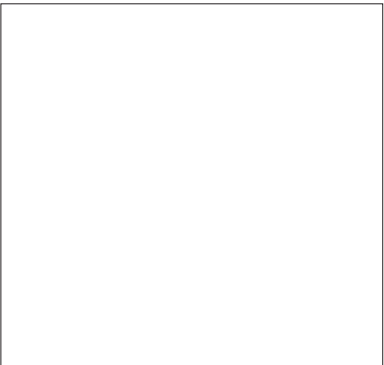
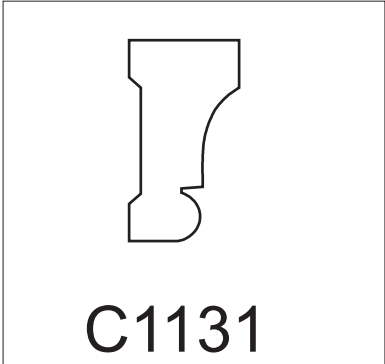
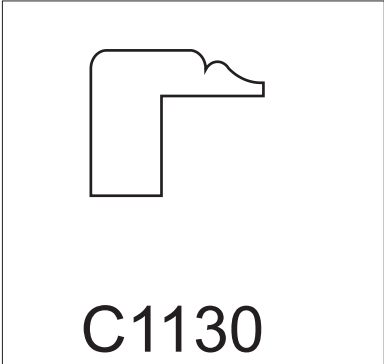
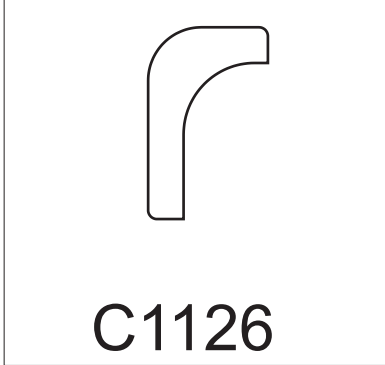
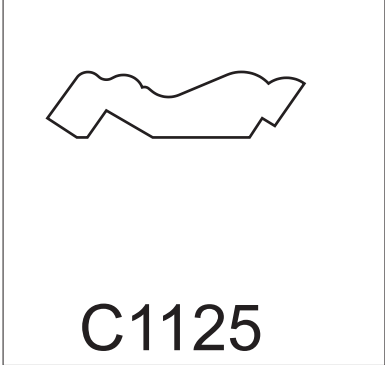
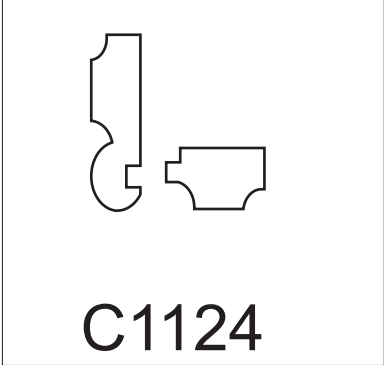

PANEL MOULDINGS 1/6

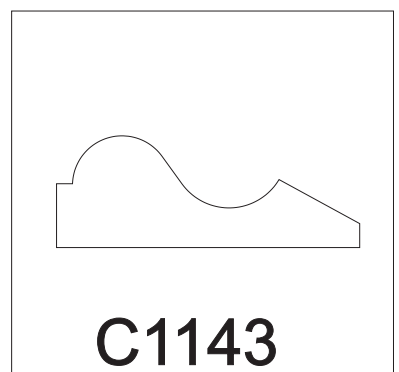
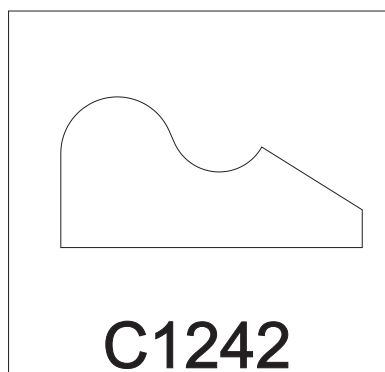
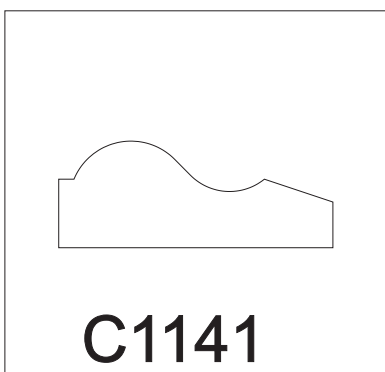
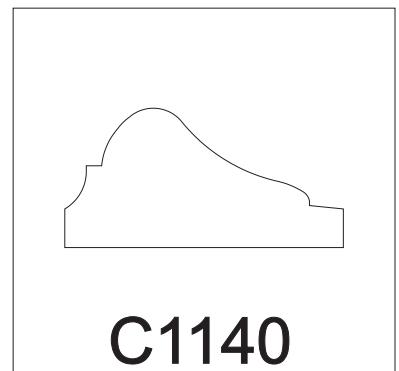
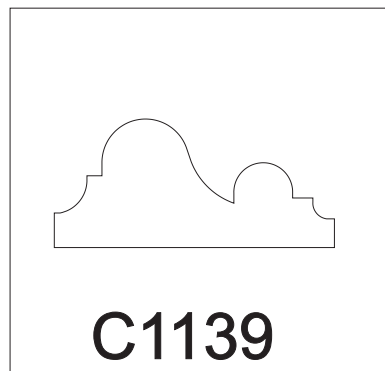
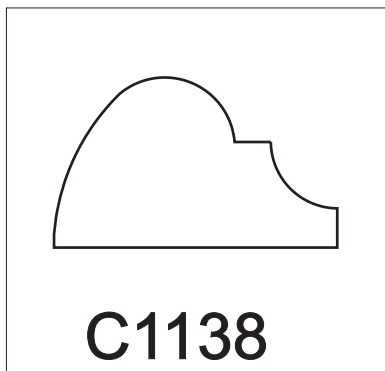
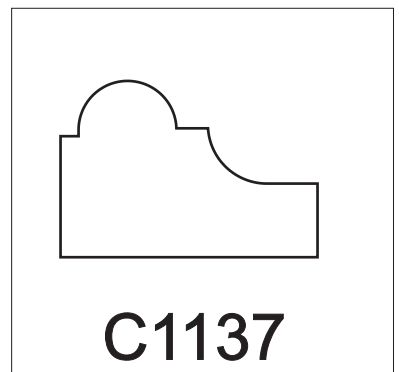
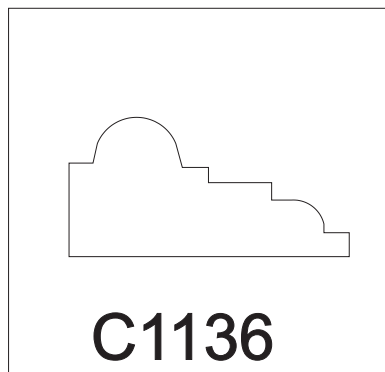
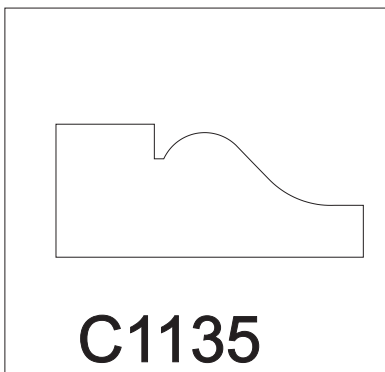
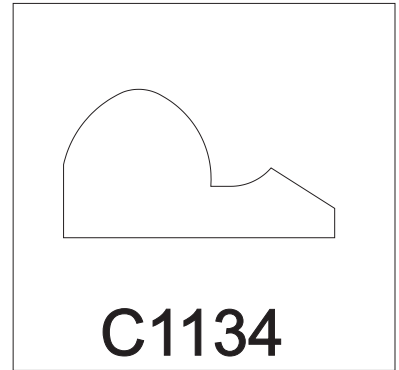
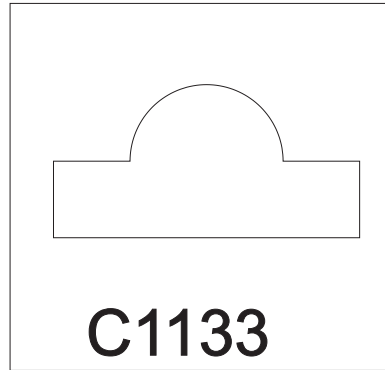
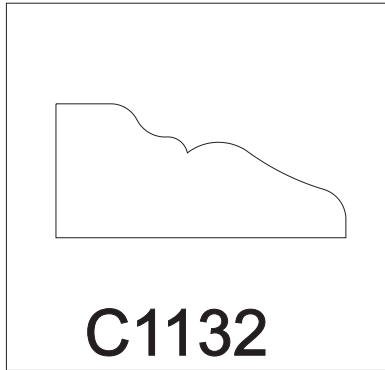

PANEL MOULDINGS 2/6

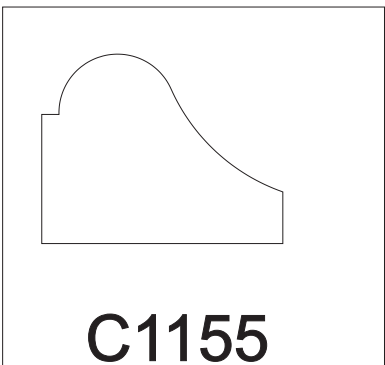
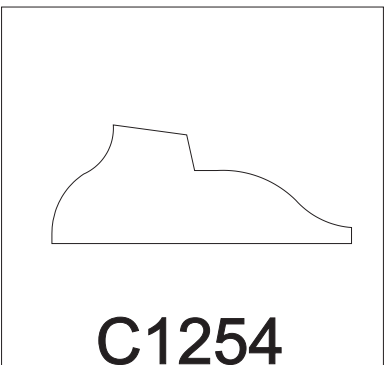
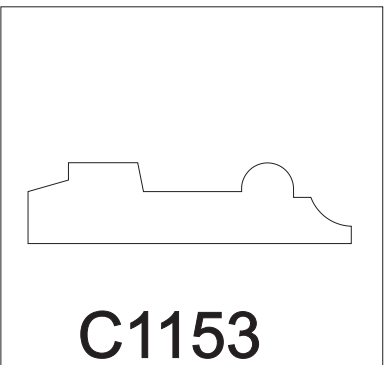
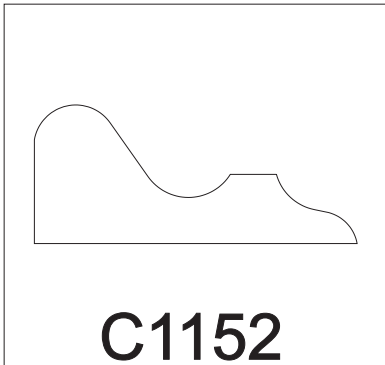
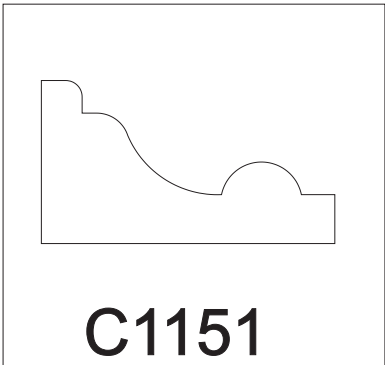
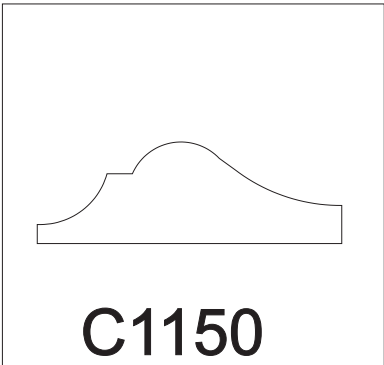
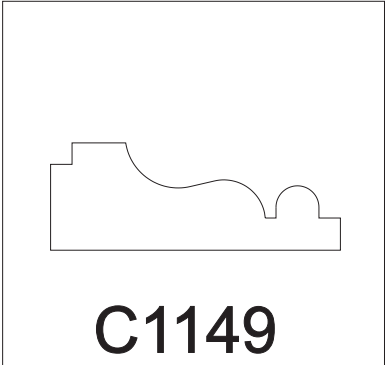
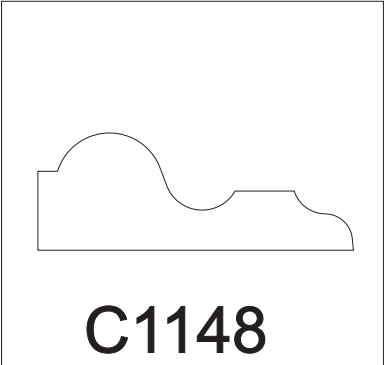
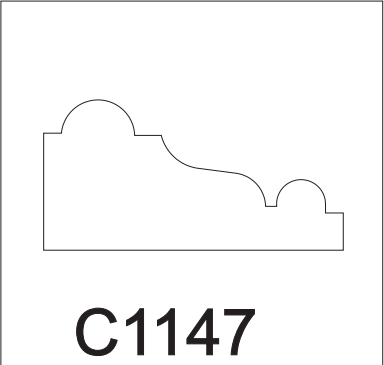
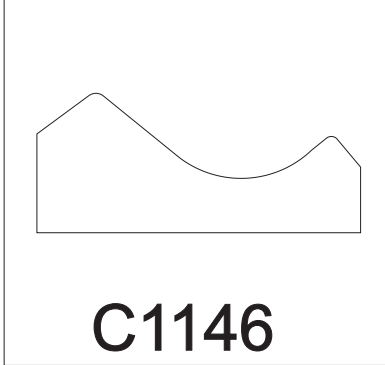
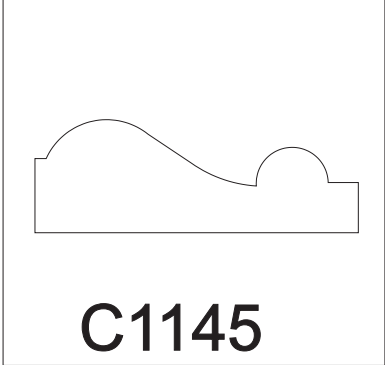
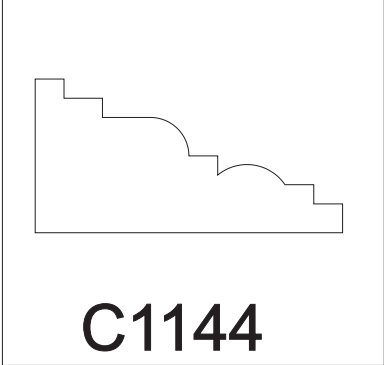

PANEL MOULDINGS 3/6

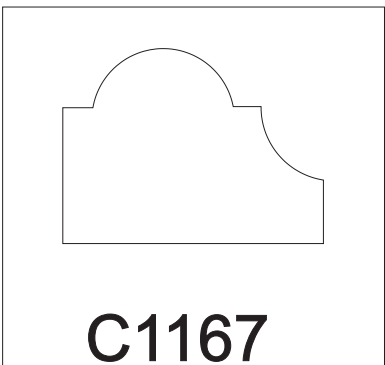
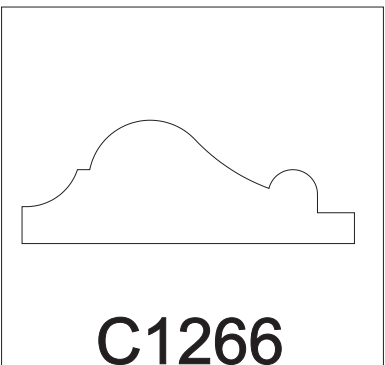
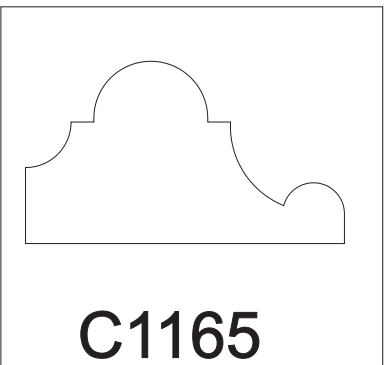
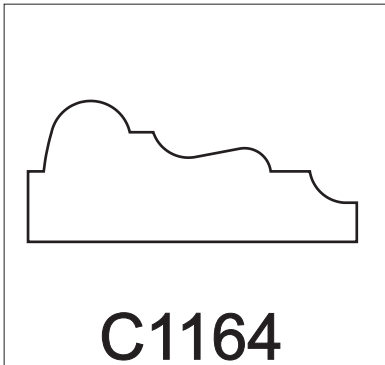
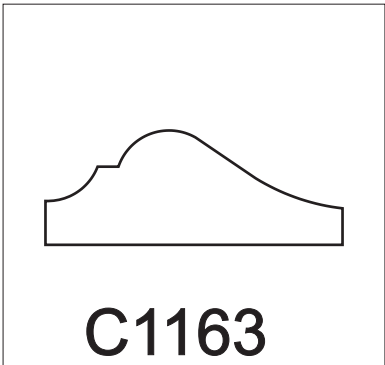
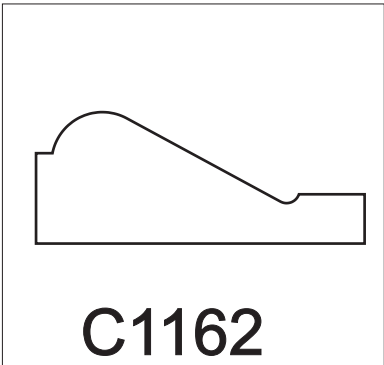
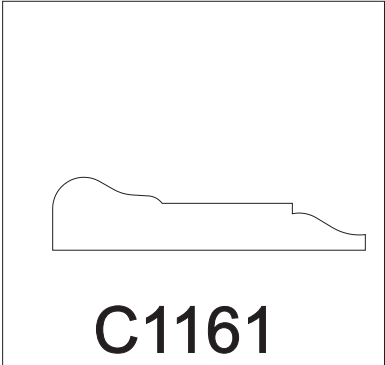
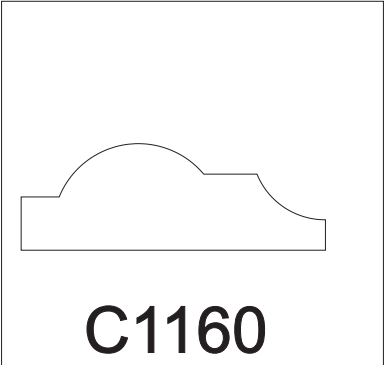
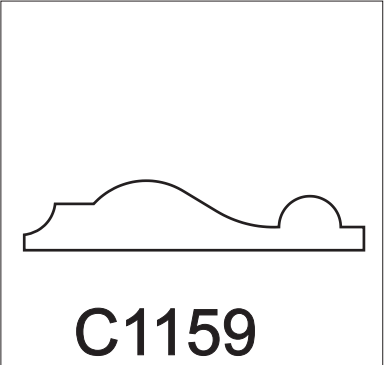
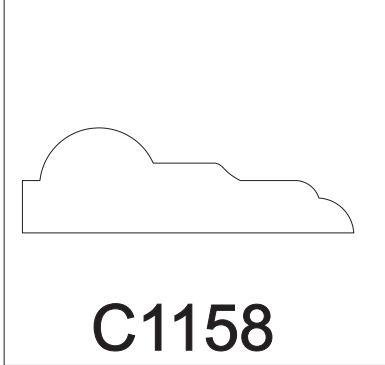
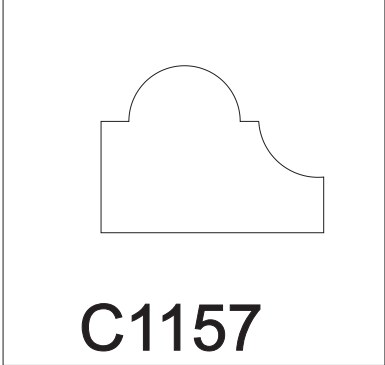
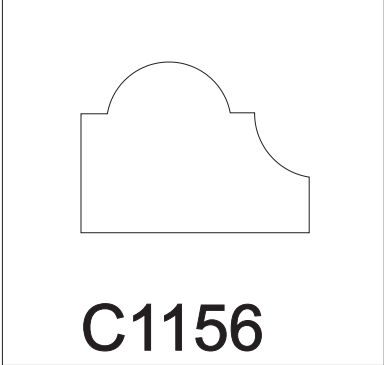

PANEL MOULDINGS 4/6

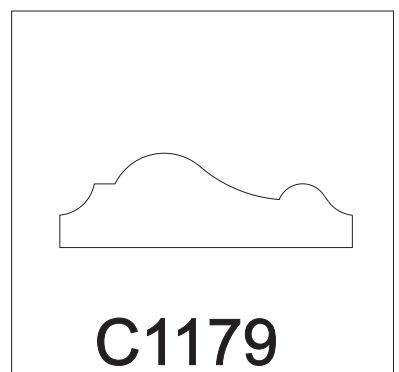
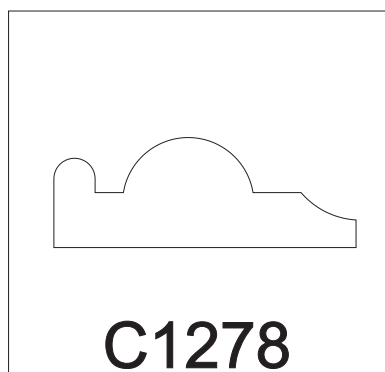
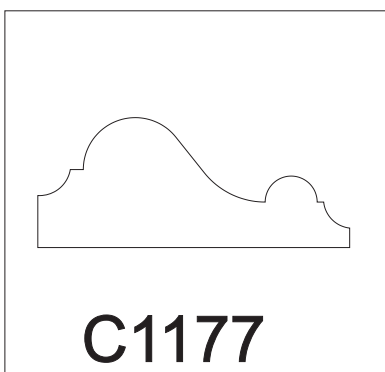
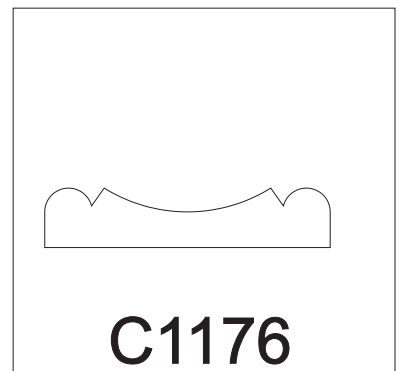
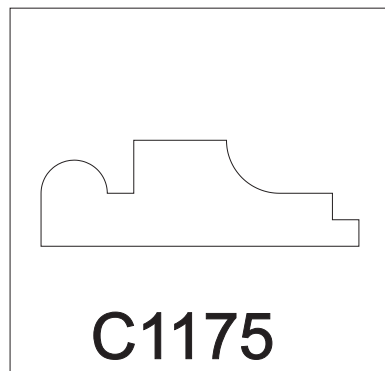
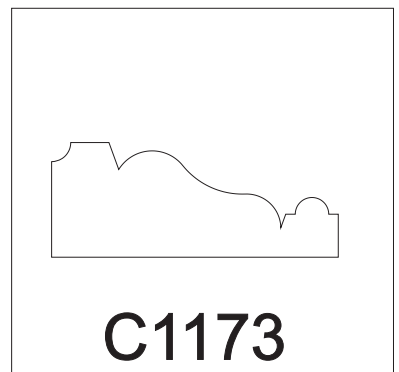
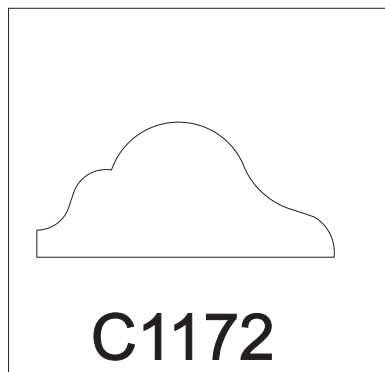
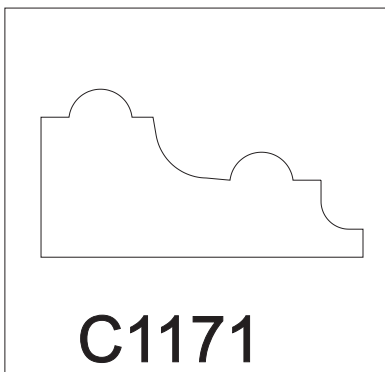
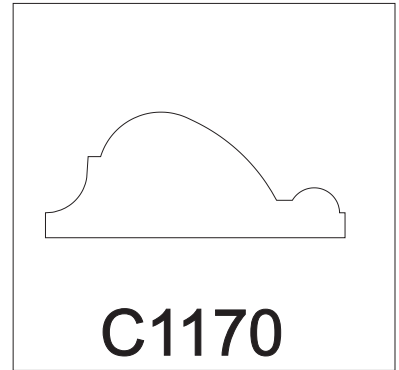
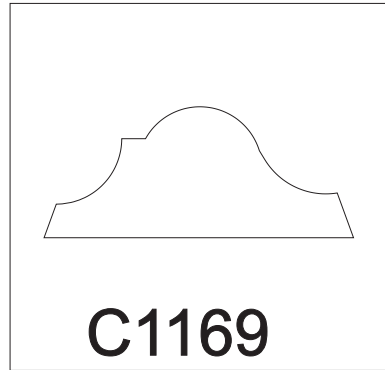
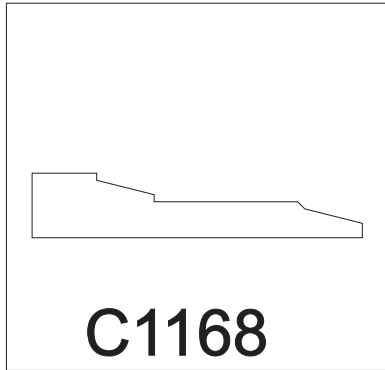

PANEL MOULDINGS 5/6

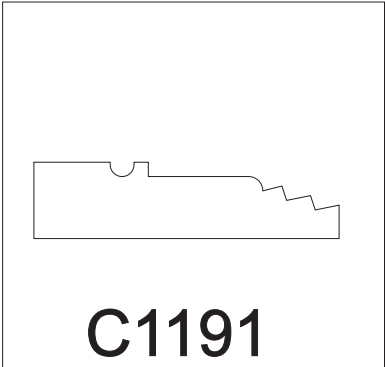
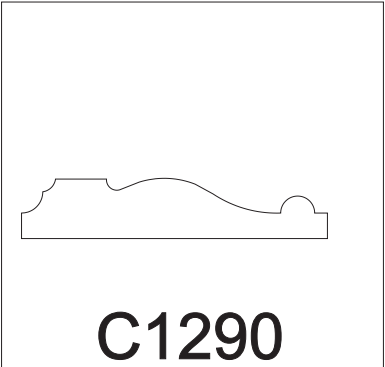
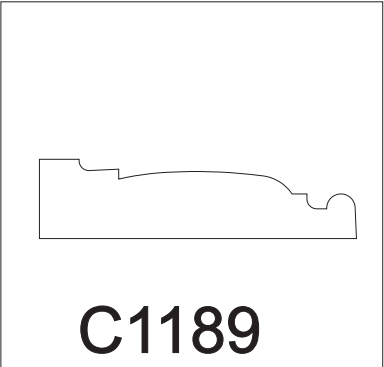
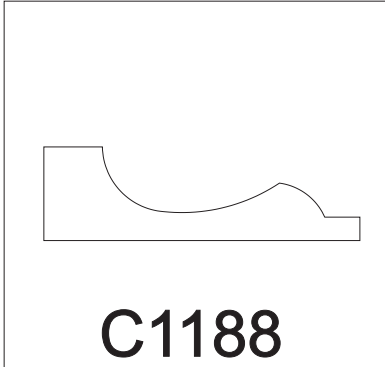
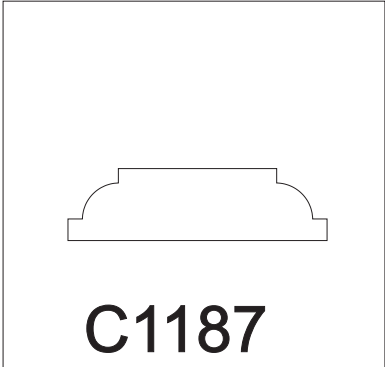
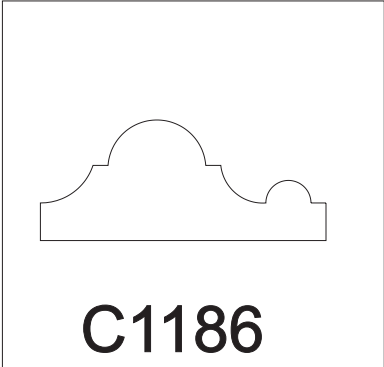
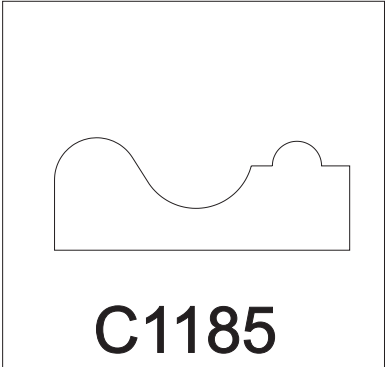
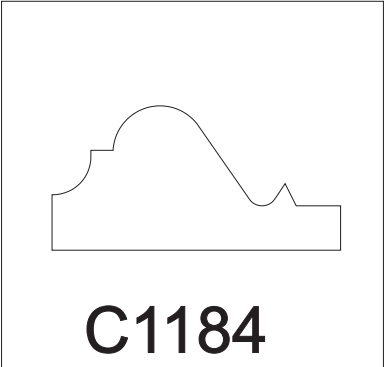
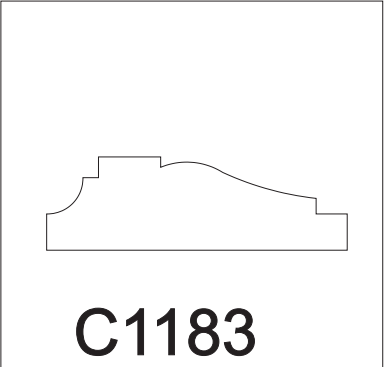
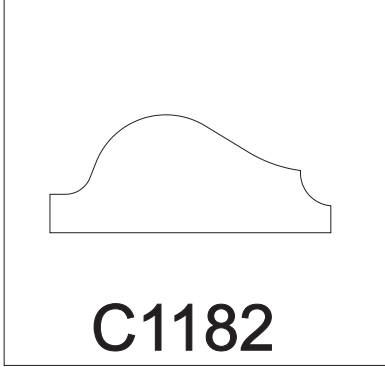
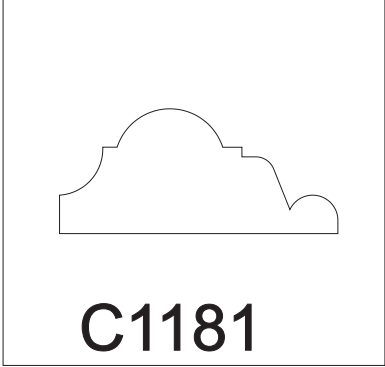
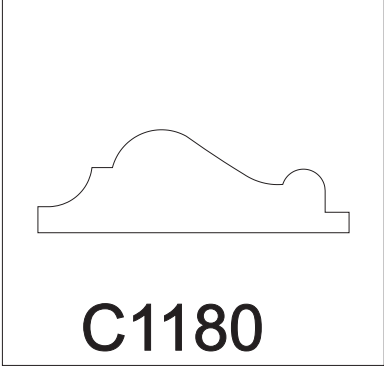

PANEL MOULDINGS 6/6

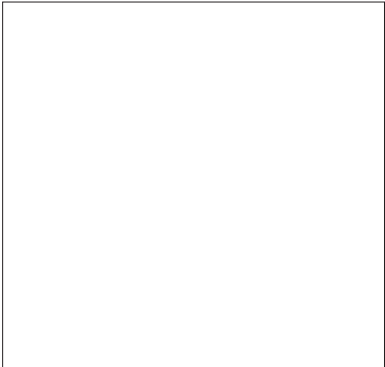
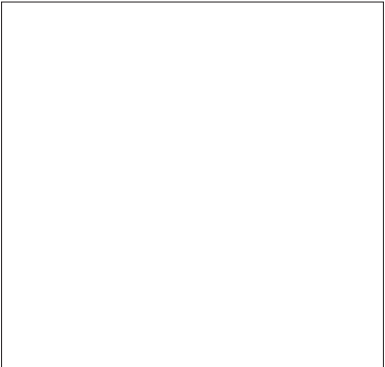
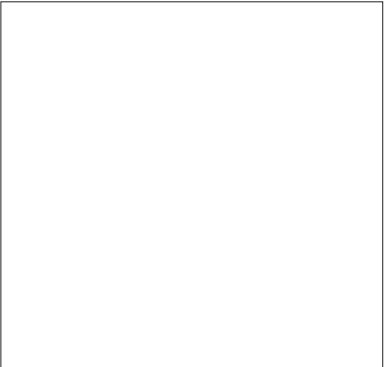
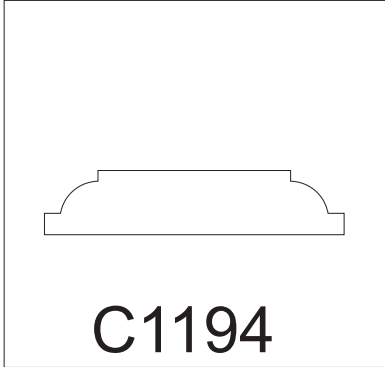
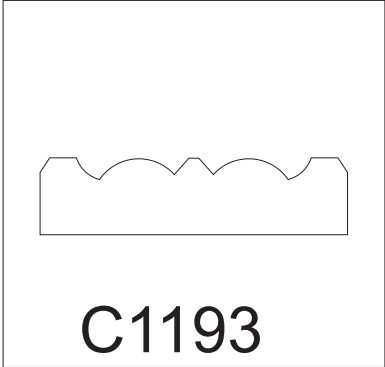
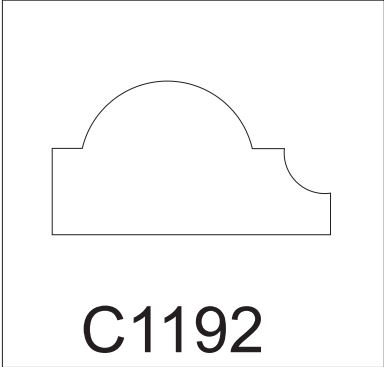

PICTURE MOULDINGS 1/4

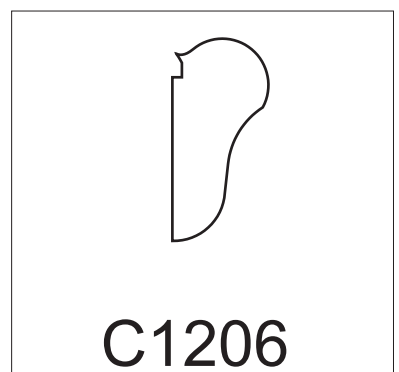
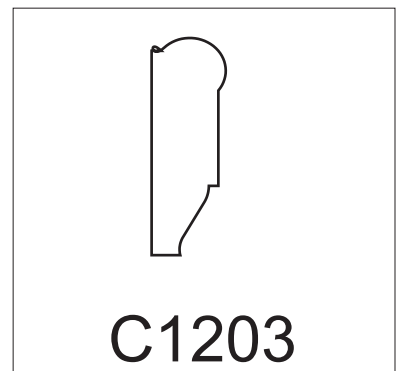
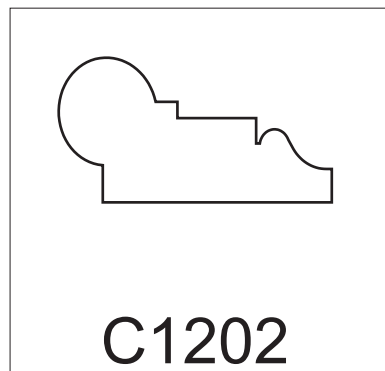
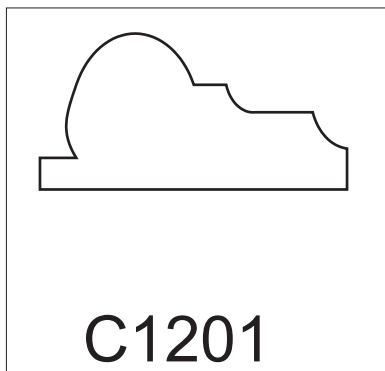
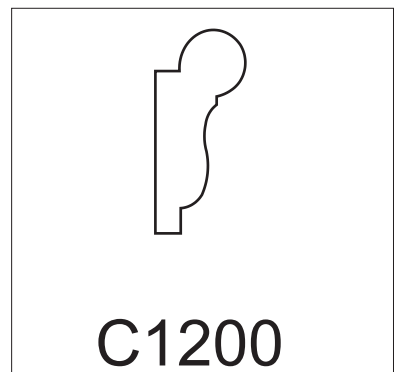
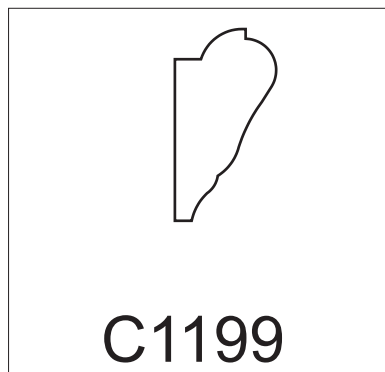
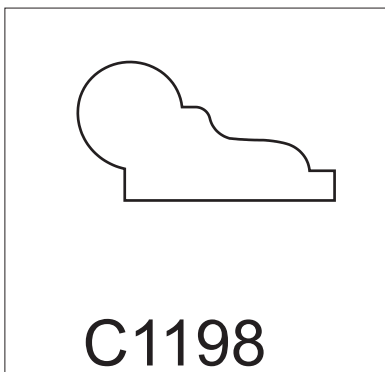
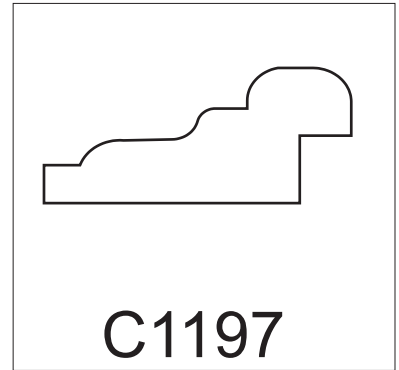
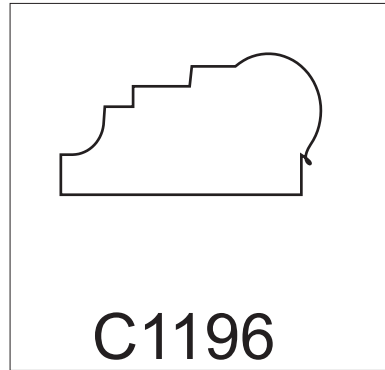
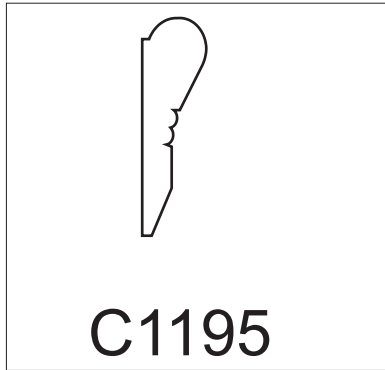

PICTURE MOULDINGS 2/4

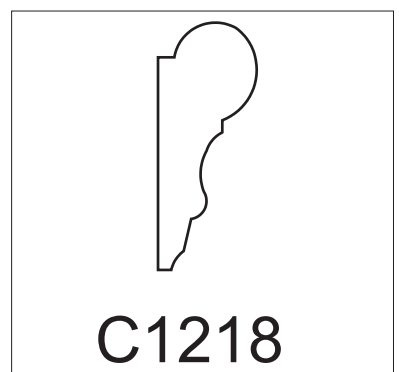
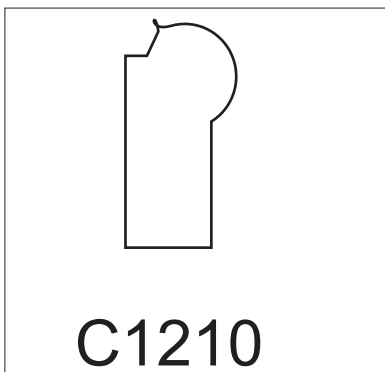
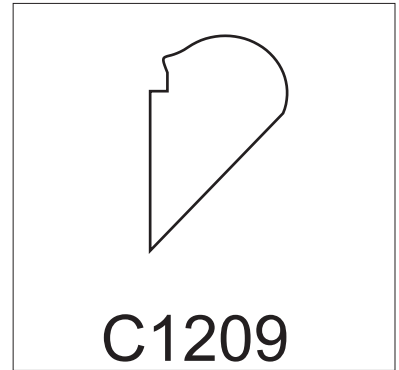
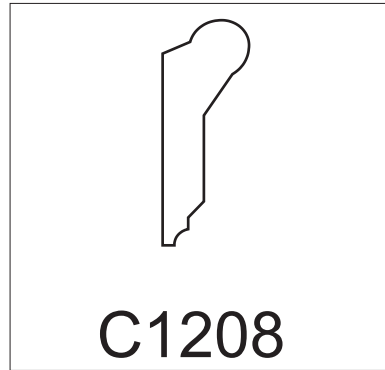
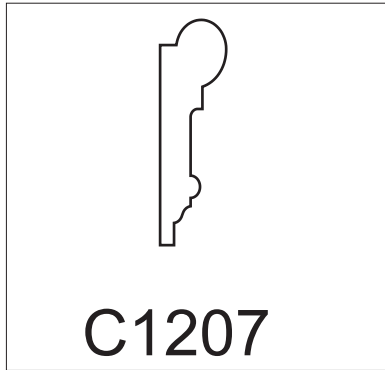

PICTURE MOULDINGS 3/4

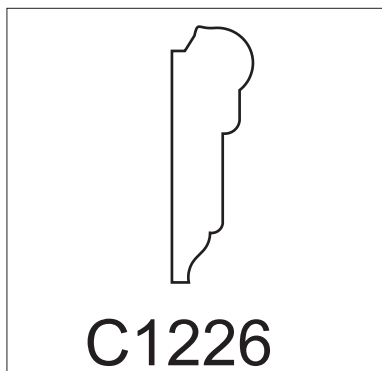
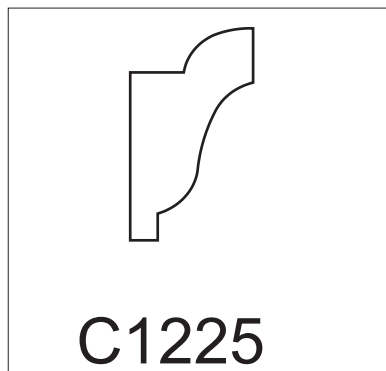
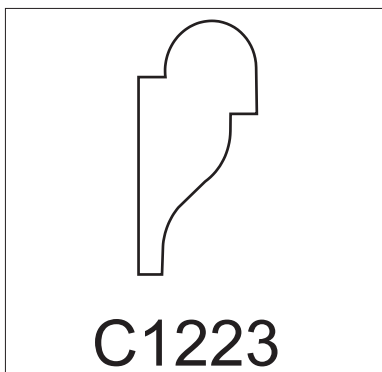
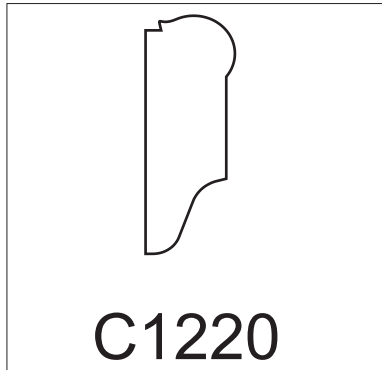
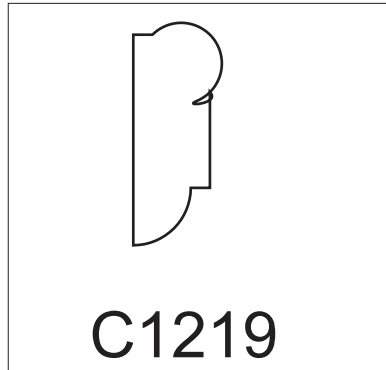

PICTURE MOULDINGS 4/4

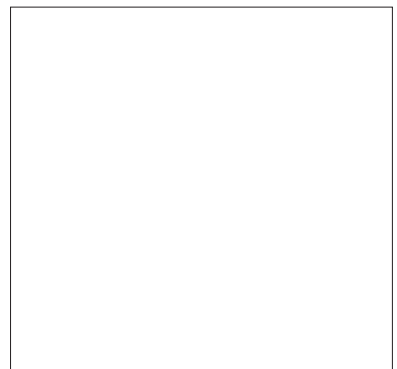
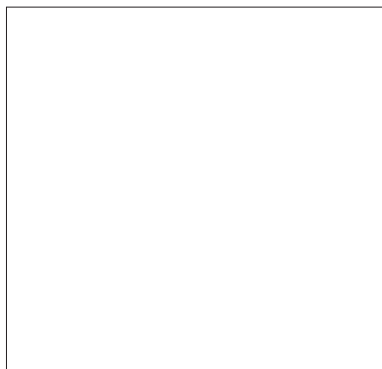
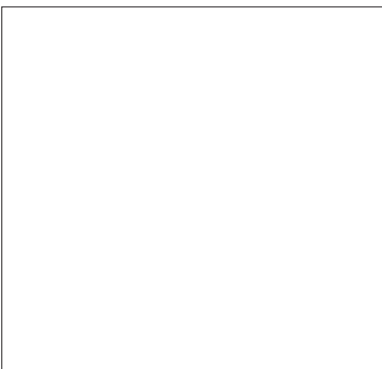
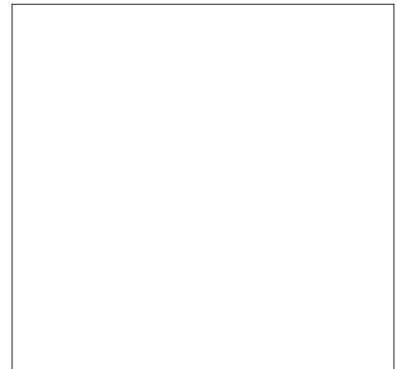
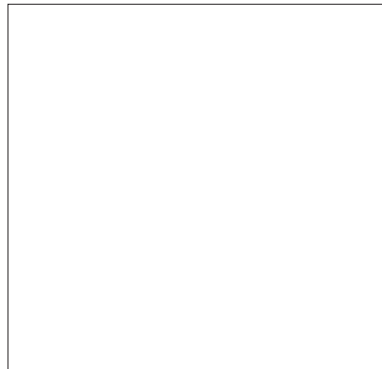
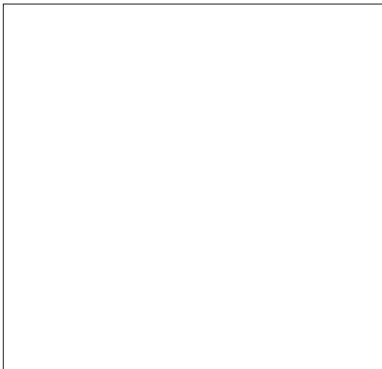
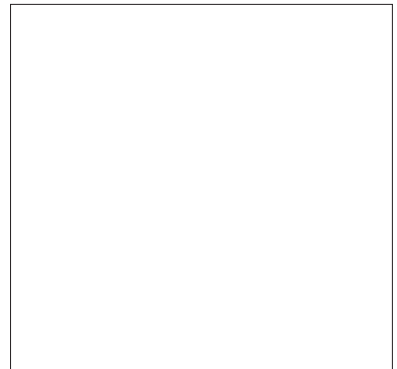
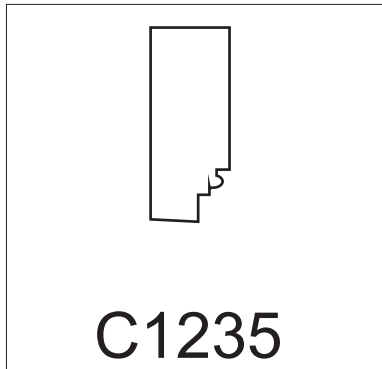
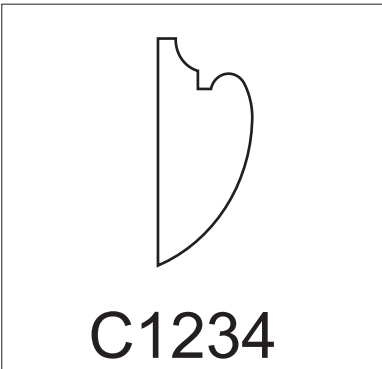
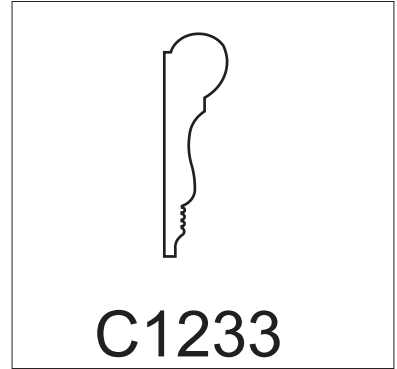
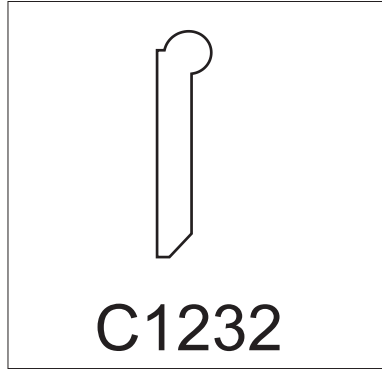
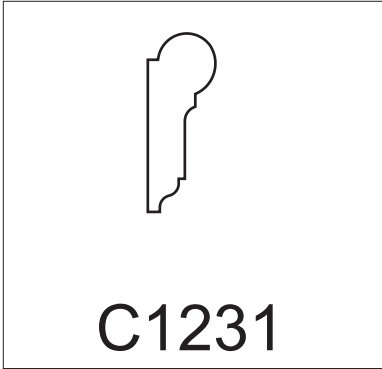

PLINTH BLOCKS 1/4

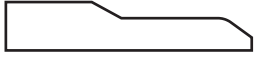

C1236

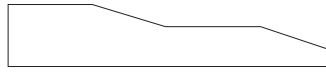

C1237



C1238

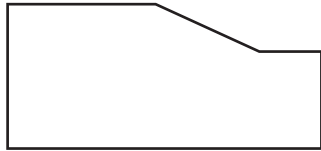

C1239

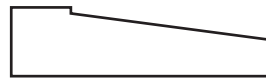

C1240



C1241

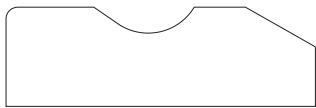

C1242



C1243

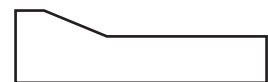

C1244

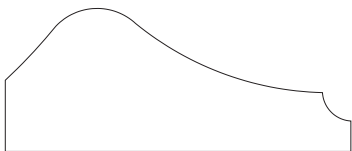

C1245



C1246



C1247

PLINTH BLOCKS 2/4

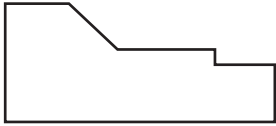

C1248



C1249

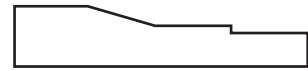

C1250

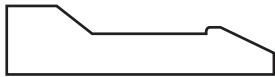

C1251

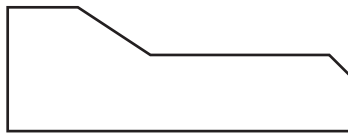

C1252



C1253

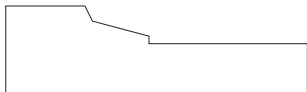

C1254

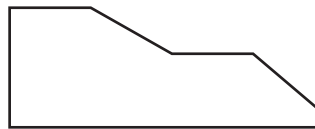

C1255



C1256

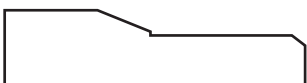

C1257

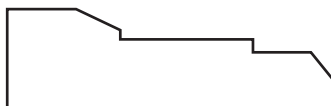

C1258



C1259

PLINTH BLOCKS 3/4

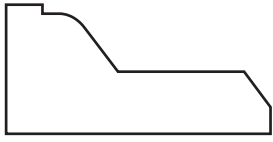

C1260

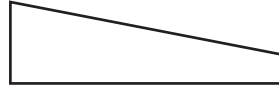

C1261

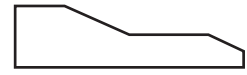

C1262

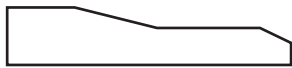

C1263

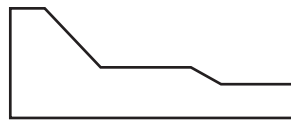

C1264



C1265

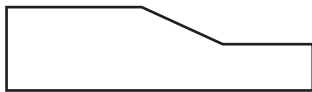

C1266

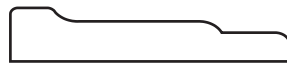

C1267



C1268



C1269



C1270

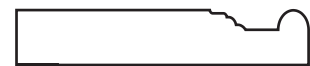

C1271

PLINTH BLOCKS 4/4

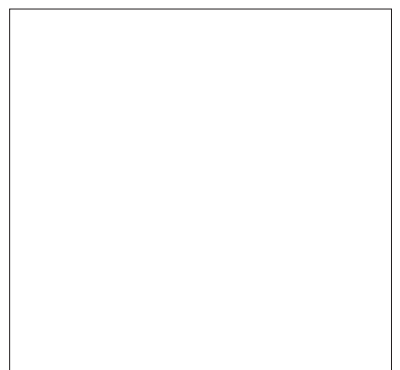
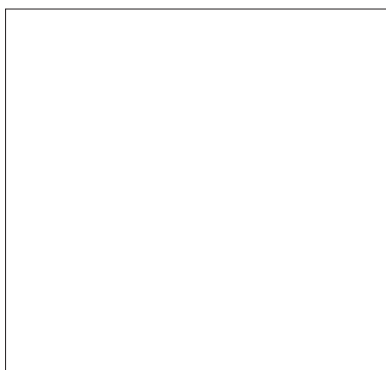
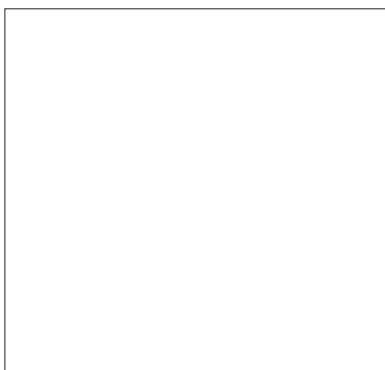
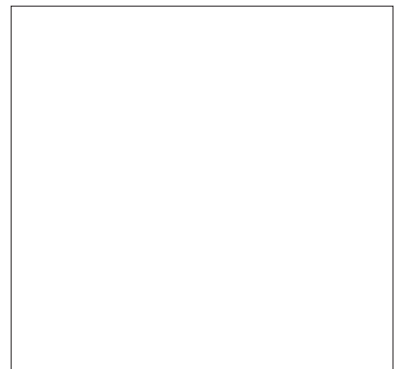
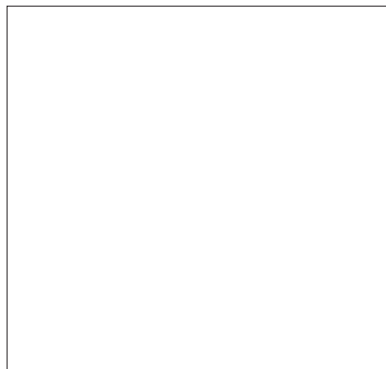
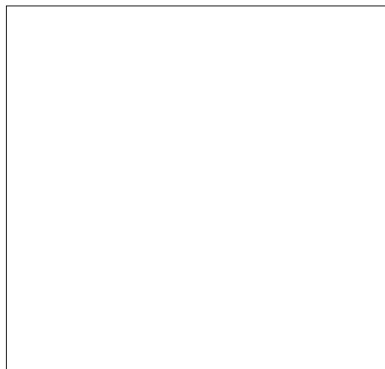
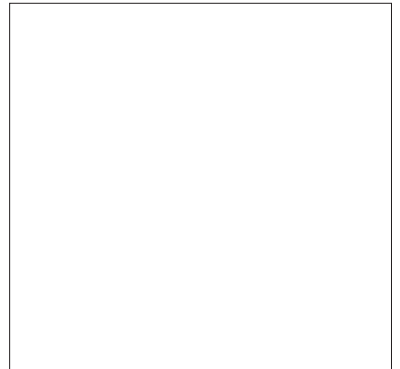
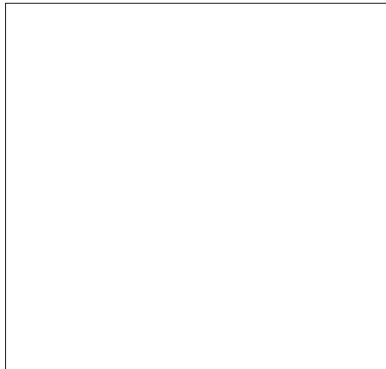
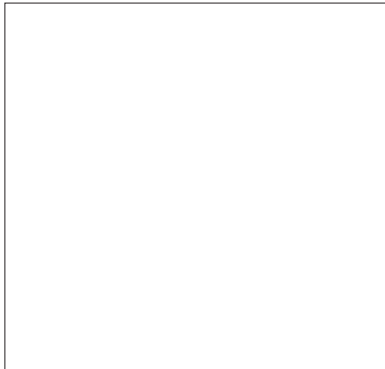
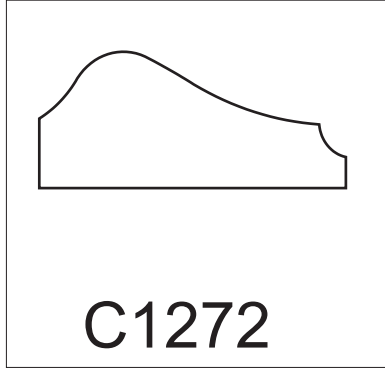

SILLS & STOOL CAPS 1/2

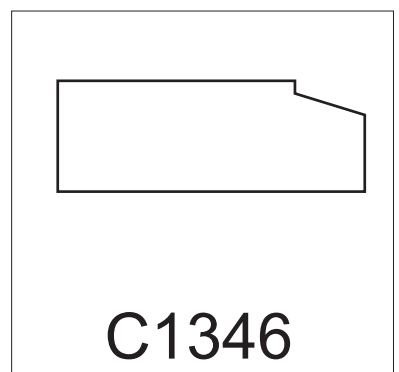
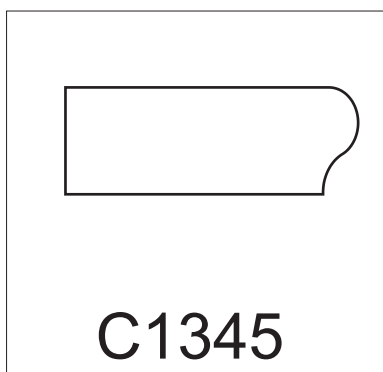
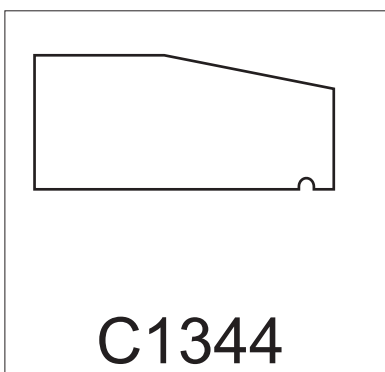
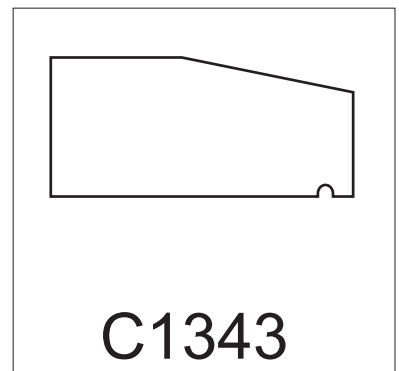
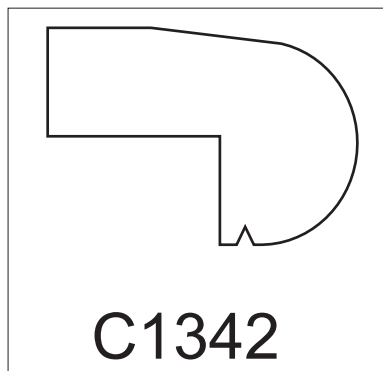
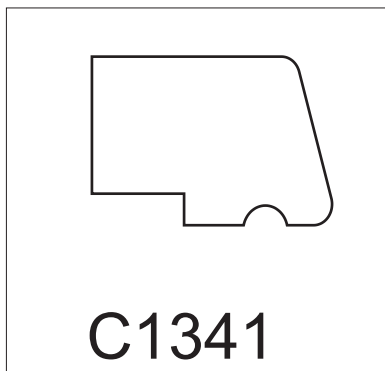
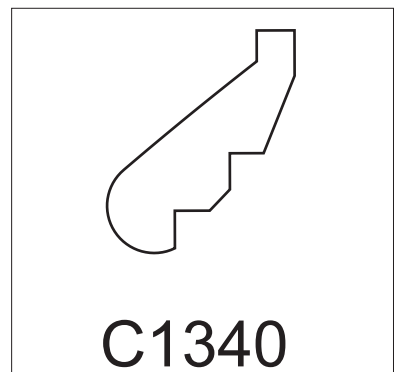
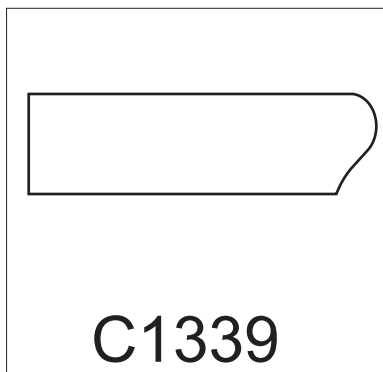
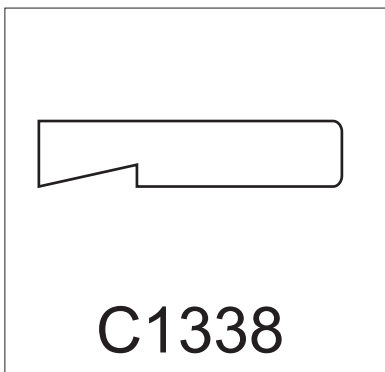
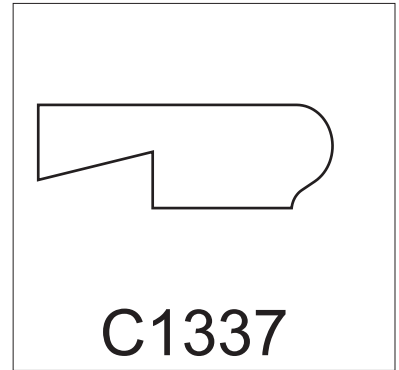
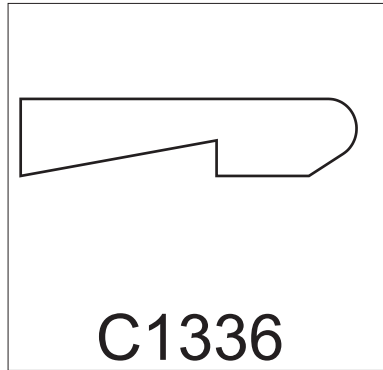
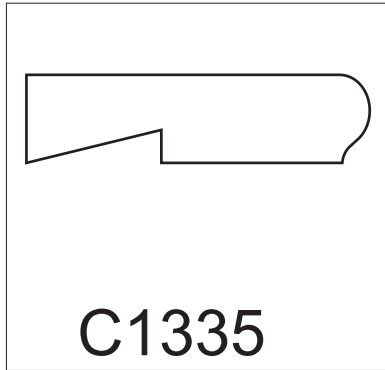

SILLS & STOOL CAPS 2/2

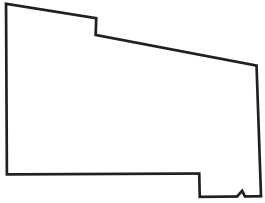

C1347

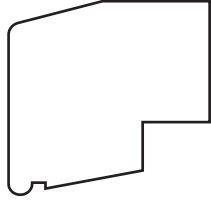

C1348

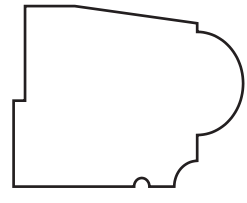

C1349



C1350

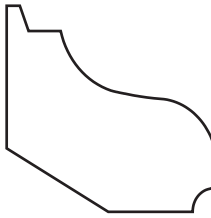

C1351



C1352



C1353

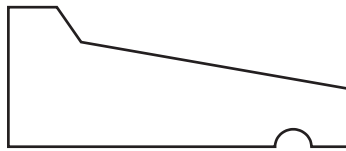

C1354

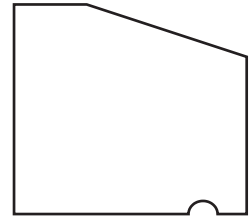

C1355

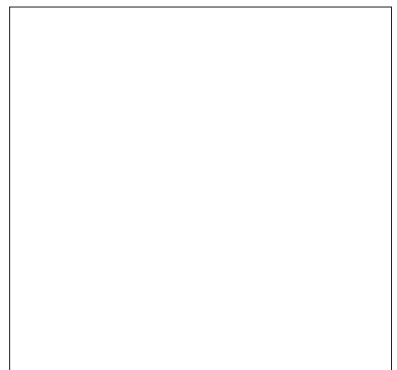
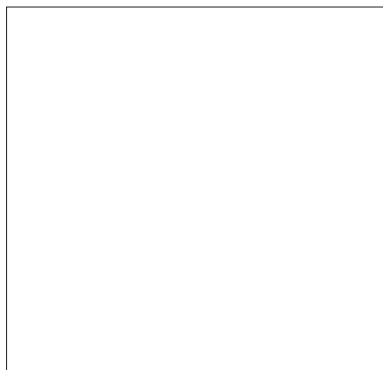
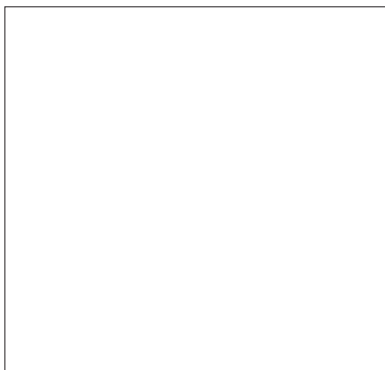

STOPS 1/3

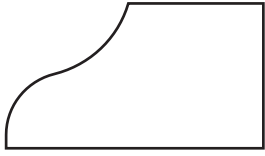

C1356

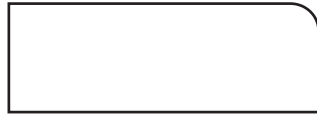

C1357

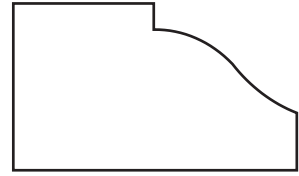

C1358



C1359



C1360



C1361

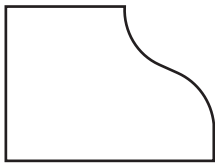

C1362

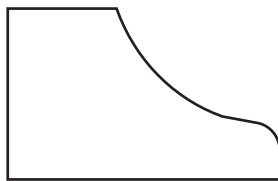

C1363



C1364

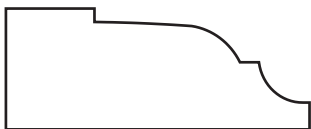

C1365



C1366



C1367

STOPS 2/3

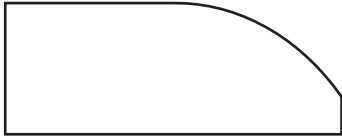

C1368

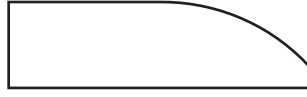

C1369



C1370

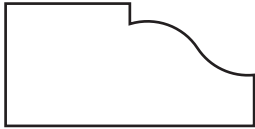

C1371



C1372

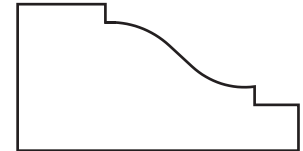

C1373

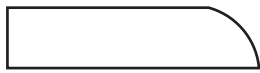

C1374



C1375



C1376



C1377

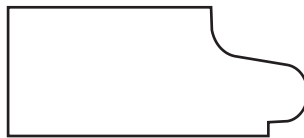

C1378



C1379

STOPS 3/3

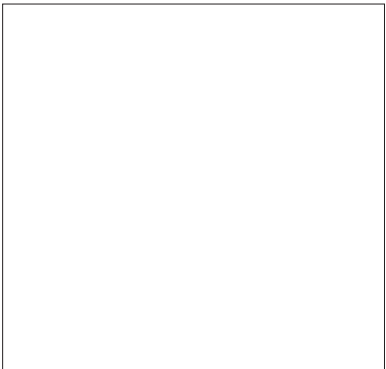
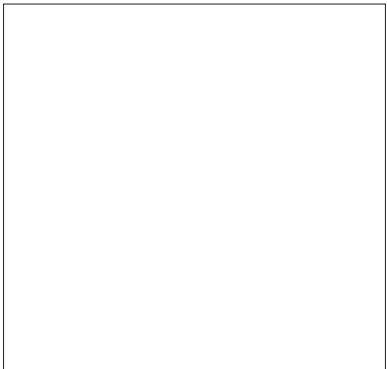
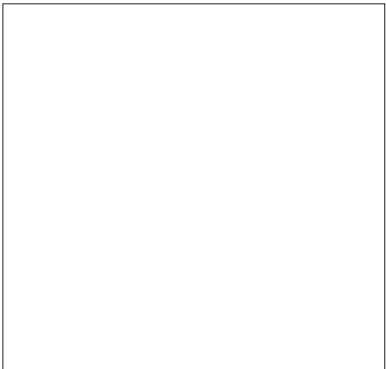
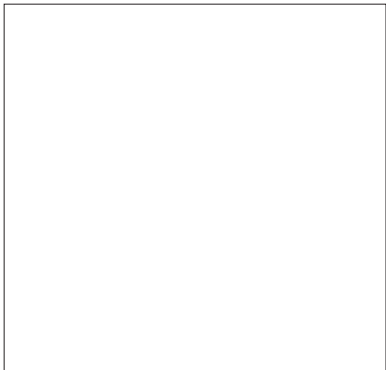
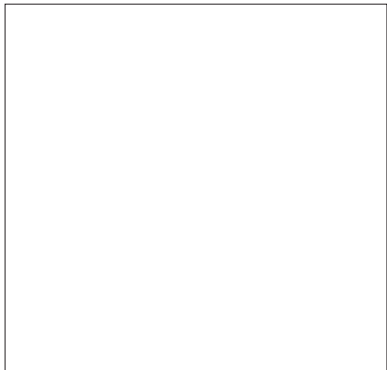
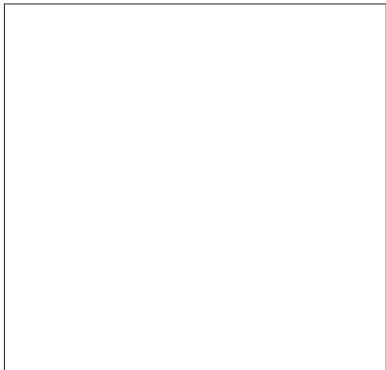
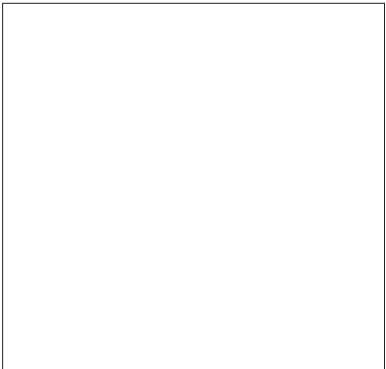
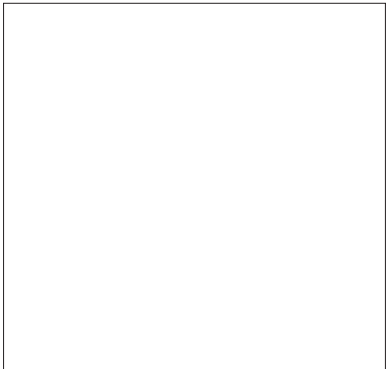
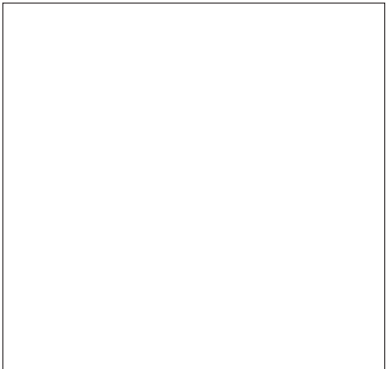
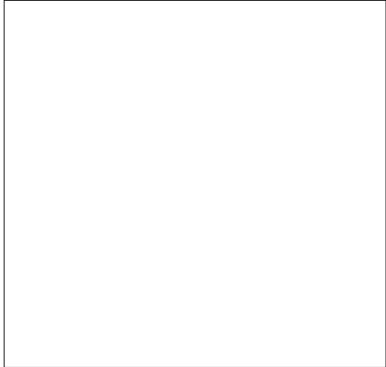
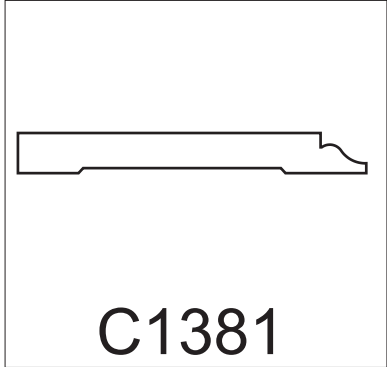
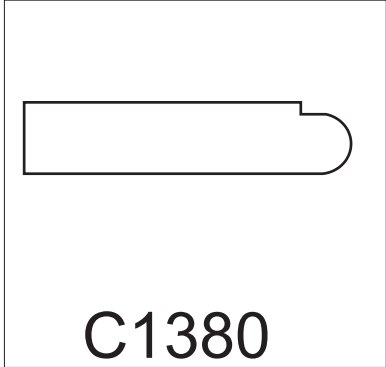

VICTORIAN CASINGS 1/9

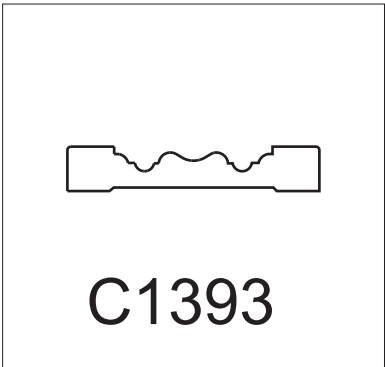
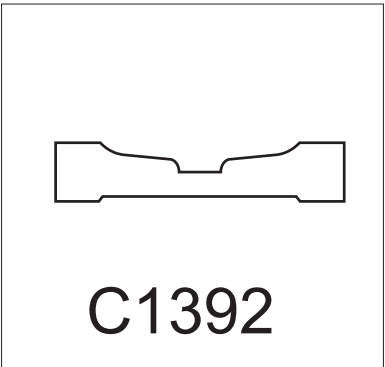
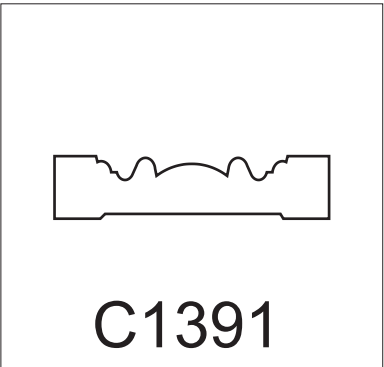
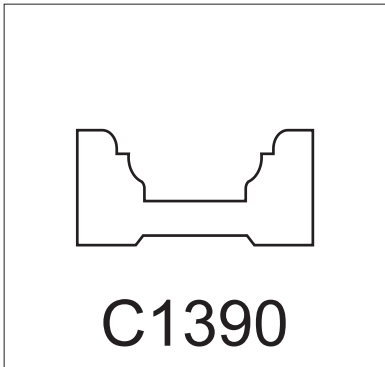
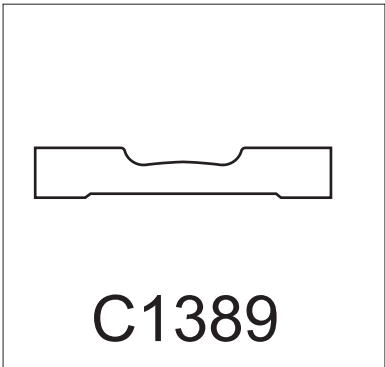
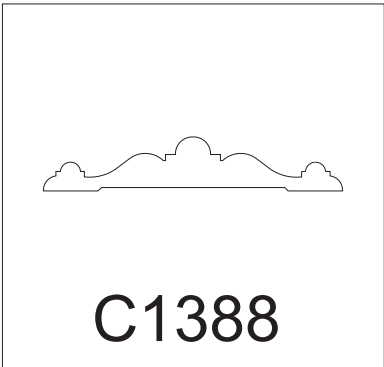
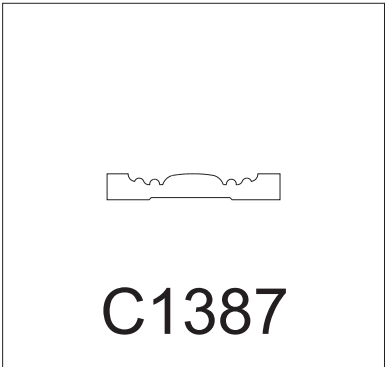
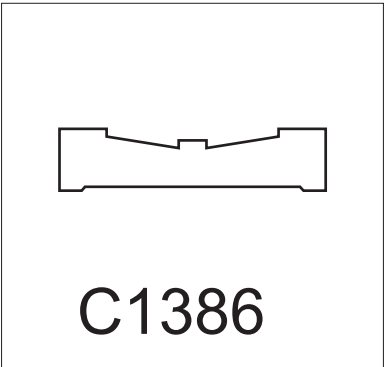
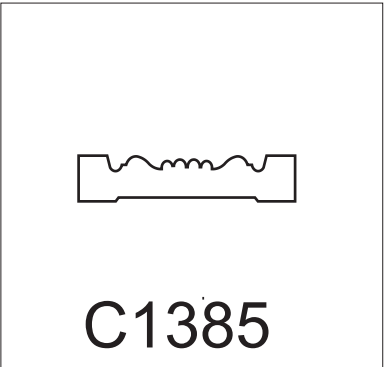
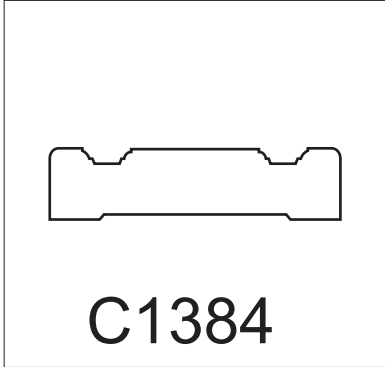
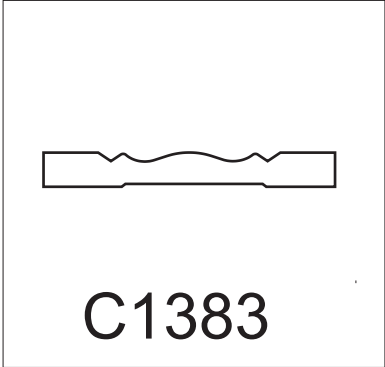
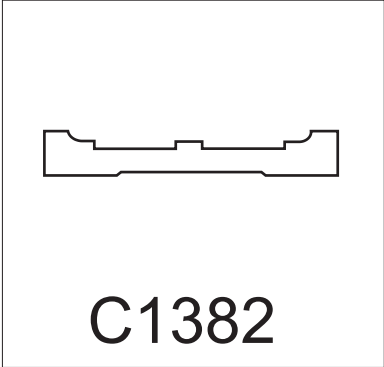

VICTORIAN CASINGS 2/9

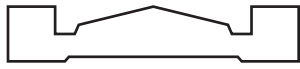

C1394



C1395



C1396



C1397

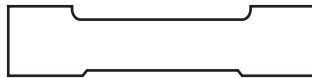

C1398



C1399



C1400



C1401



C1402



C1403

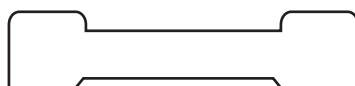

C1404



C1405

VICTORIAN CASINGS 3/9

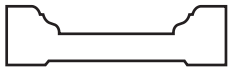

C1406

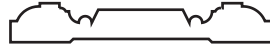

C1407



C1408



C1409



C1410

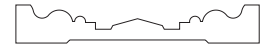

C1411



C1412

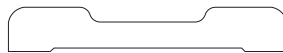

C1413

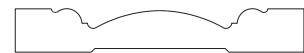

C1414



C1415



C1416



C1417

VICTORIAN CASINGS 4/9



C1418



C1419

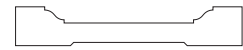

C1420

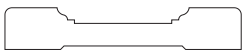

C1421



C1422

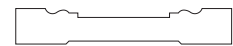

C1423



C1424

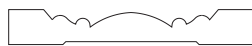

C1425

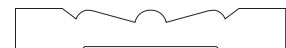

C1426



C1427

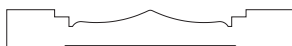

C1428



C1429

VICTORIAN CASINGS 5/9



C1430

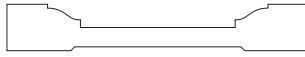

C1431



C1432

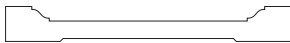

C1433

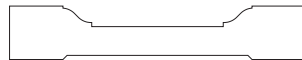

C1434



C1435

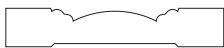

C1436



C1437



C1438



C1439



C1440

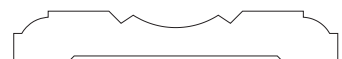

C1441

VICTORIAN CASINGS 6/9

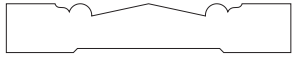

C1442



C1443



C1444

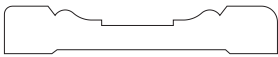

C1445

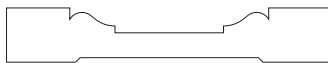

C1446



C1447



C1448



C1449

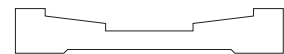

C1450

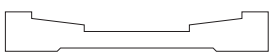

C1451

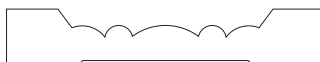

C1452



C1453

VICTORIAN CASINGS 7/9

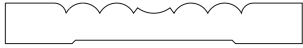

C1454



C1455



C1456



C1457

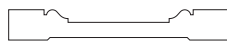

C1458



C1459

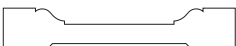

C1460



C1461



C1462



C1463



C1464



C1465

VICTORIAN CASINGS 8/9

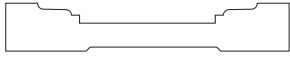

C1466



C1467

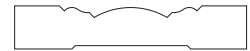

C1468



C1469



C1470



C1471

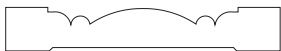

C1472



C1473



C1474



C1475

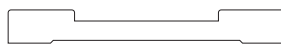

C1476



C1477

VICTORIAN CASINGS 9/9



C1478

